

TCW241

Ethernet controller

User manual

Version 1.0 / January, 2016



Ethernet controller TCW241

1. Introduction

TCW241 is a multi-functional device for monitoring and control in Ethernet based networks. It has 4 digital inputs, 4 analog inputs, 1-Wire interface for up to 8 Teracom 1-Wire sensors like temperature, humidity, CO2, current, 4/20mA, galvanic isolated analog voltage etc. It also has 4 relays with normally open and normally close contacts.

The relays can be activated either remotely (WEB, SNMP, HTTP API, MODBUS etc.) or locally – from the status of a monitored parameter (1 Wire sensor, analog voltage and dry contact).

XML/JSON file with all monitored parameters can periodically uploaded on dedicated server by HTTP Post. Like answer server can return commands for relay's control. This is a way for building SCADA system. For every parameter e-mails and SNMP traps for up to 5 recipients can be sent. Alarm alert also can be sent by HTTP Post with XML/JSON status files.

An Embedded real time clock provides scheduled time control of selected outputs: the tasks can be either single or with weekly repetition.

2. Features

- 10/100 Mb Ethernet connectivity;
- Auto-MDIX;
- Password protected, web based configuration and control;
- 4 digital inputs with " dry contact" and "logic level" modes;
- 4 analog inputs with 0 to 60VDC range;
- Multiplier and offset for analog inputs
- 4 relays with NO and NC contacts;
- 1-Wire interface for up to 8 temperature (TST1XX), temperature/humidity (TSH2xx) or other Teracom sensors;
- SNMP v.2 support;
- SNMP traps and/or e-mail sending for alert conditions;
- SMTP with authentication;
- 2K SSL support;
- HTTP and SNMP port changing;
- HTTP API commands;
- Periodical HTTP Post of XML/JSON status files for client-server systems;
- MODBUS support;
- NTP protocol support;
- Real time clock for scheduled control;
- Extended working temperature range;
- Wide power supply voltage range;
- Remote firmware update.

3. Applications

TCW241 is suitable for environmental monitoring and local control of electrical and non-electrical parameter, industrial and building automation, data acquisition systems, general remote control and monitoring.

It works very well as a standalone device that can be controlled using a web browser or as a part of small and medium industrial control systems for SCADA (supervisory control and data acquisition).

A few example applications include:

- Temperature and humidity control in data centers;
- Building management system;
- Industrial cooling/heating control;
- Home automation;
- Alarm systems;
- Mushroom plant automation;
- Process monitor;

4. Technical parameters

Supply voltage, VDC	10 - 32
Maximum current (with all relays ON), mA	350@12VDC
Weight, g	230
Dimensions, mm	145 x 90 x 40
Operating temperature, °C	-20 to +55
Maximum humidity, %RH	70
Minimum high level input voltage for digital inputs, VDC	+2.5
Maximum low level input voltage for digital inputs, VDC	+0.8
Maximum input voltage for digital inputs, VDC	+5.5
Supply voltage for 1-Wire bus (VDD), VDC	5.0 ± 0.3
Maximum output current for 1-Wire bus (VDD), A	0.2
Analog inputs range, VDC	0 to 60
Analog inputs resolution, VDC	0.01
Analog inputs accuracy, %	± 1
Maximum switchable current, A	3
Maximum switchable voltage, VAC/VDC	30/24

5. LED indicators

The following indicators show the status of the controller:

- **Relay1-Relay4** (green) – these LEDs are illuminated whenever the corresponding relay is activated (the NO contact is closed and the NC contact is open);
- **PWR** (red) – in working mode shines, blinks together with STS if there is a hardware error;
- **STS** (yellow) – flashes when the main program of controller is executed;
- **Link** (green) – located on the Ethernet connector, indicates that the device is connected to the network;
- **Act** (yellow) – located on the Ethernet connector, flashes when activity is detected on the network.

6. Installation and setup

This device must be installed by qualified personnel.

This device must not be installed directly outdoors.

Installation consists of mounting the device, connecting to an IP network, connecting inputs and outputs, providing power and configuring via a web browser.

6.1. Mounting

TCW241 should be mounted in a clean and dry location on not flammable surface. Ventilation is recommended for installations where ambient air temperature is expected to be high.

Mount the device to a wall by using two plastic dowels 8x60mm (example Würth GmbH 0912 802 002) and two dowel screws 6x70mm (example Würth GmbH 0157 06 70). Attach the screws to the surface vertically. See Appendix-A, fig. 1 for mechanical details.

Maintain spacing from adjacent equipment. Allow 50 mm of space on all sides, as shown on fig.2 in Appendix A, this provides ventilation and electrical isolation

TCW241 can be mounted to a standard (35mm by 7.55mm) DIN rail. Attach the controller to the DIN rail by hooking the hook on the back of the enclosure to the DIN rail and then snap the bottom hook into place.

6.2. Connection

Attention! Disconnect power supply before wiring.

The correct wiring procedure is as follows:

- Make sure power is turned off;
- Make wiring connections to the terminals;
- Apply power.

It is recommended to test and configure **TCW241** without any controlled device. In this case unexpected turn on will be avoided.

Make sure that wires are properly attached to the terminals and that the terminals are tighten. Not proper wiring and configuration can cause permanent damage of **TCW241** or the equipment to which it is connected or both.

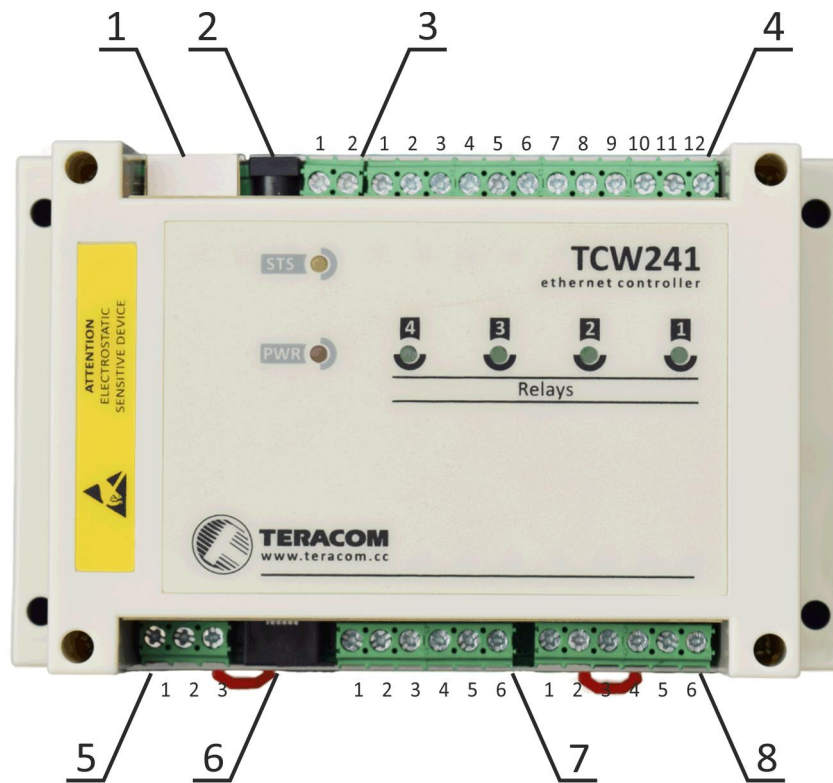

- | | | | |
|--------------------|---|--------------------|--|
| Connector 1 | Ethernet - RJ45 | Connector 6 | Pin1 – GND (most left)
Pin2 – GND
Pin3 – 1-Wire Data
Pin4 – 1-Wire GND
Pin5 – 1-Wire +VDD
Pin6 – 1-Wire +VDD (most right) |
| Connector 2 | Power - central positive | Connector 7 | Pin1 – Digital In 1
Pin2 – GND
Pin3 – Digital In 2
Pin4 – Digital In 3
Pin5 – GND
Pin6 – Digital In 4 |
| Connector 3 | Pin1 – Power positive
Pin2 – Power negative | Connector 8 | Pin1 – Analog In 1
Pin2 – GND
Pin3 – Analog In 2
Pin4 – Analog In 3
Pin5 – GND
Pin6 – Analog In 4 |
| Connector 4 | Pin1 – NC Relay4
Pin2 – COM Relay4
Pin3 – NO Relay4
Pin4 – NC Relay3
Pin5 – COM Relay3
Pin6 – NO Relay3
Pin7 – NC Relay2
Pin8 – COM Relay2
Pin9 – NO Relay2
Pin10 – NC Relay1
Pin11 – COM Relay1
Pin12 – NO Relay1 | | |
| Connector 5 | Pin1 – 1-Wire GND
Pin2 – 1-Wire Data
Pin3 – 1-Wire +VDD | | |

6.2.1. Power supply connection

TCW241 is designed to be supplied by adapter SYS1421-0612-W2E or similar, intended for use in the conditions of overvoltage category II, and priory assessed for compliance with safety requirements. The power supply equipment shall be resistant to short circuit and overload in secondary circuit.

When in use, do not position the equipment so that it is difficult to disconnect the device from the power supply.

6.2.2. Digital inputs connection

Attention! Digital inputs are NOT galvanic isolated.

The TCW241 Digital inputs can be used in two modes – “dry contact” and “logic level”. The mode is determined by the jumper, close to the corresponding input. Closed jumper determines “dry contact” mode while open “logic level”. By default digital inputs are in “dry contact” mode.

In “dry contact” mode digital inputs can be used to monitor the state of a discrete device – door contact switch, push button, PIR detector etc.

Following picture illustrates how a dry contact switch can be connected to the input (or inputs) of TCW241. One side of the contact is connected to “Digital In” and the other side is connected to “GND” terminals.

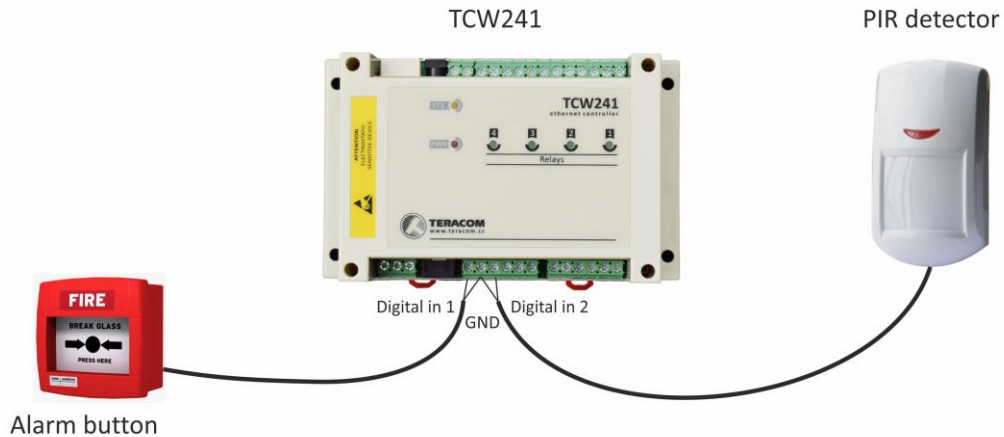

The total cable length should be up to 30 meters.

6.2.3. Analog inputs connection

Attention! Analog inputs are NOT galvanic isolated.

Analog inputs of TCW241 can be used for monitoring of DC voltage up to 60VDC. They can be connected directly to batteries, solar panels, power supplies etc.

Built in functionality “Multiplier”, “Offset” and “Dimension” for every analog input gives possibility to monitor sensors with analog outputs and see directly measured parameter. It is also possible to monitor voltages bigger than 60 VDC with external resistive dividers.

Following picture illustrates how a battery can be connected to the analog input of **TCW241**. One side of the contact is connected to “Analog In” and the other side is connected to “GND” terminals.

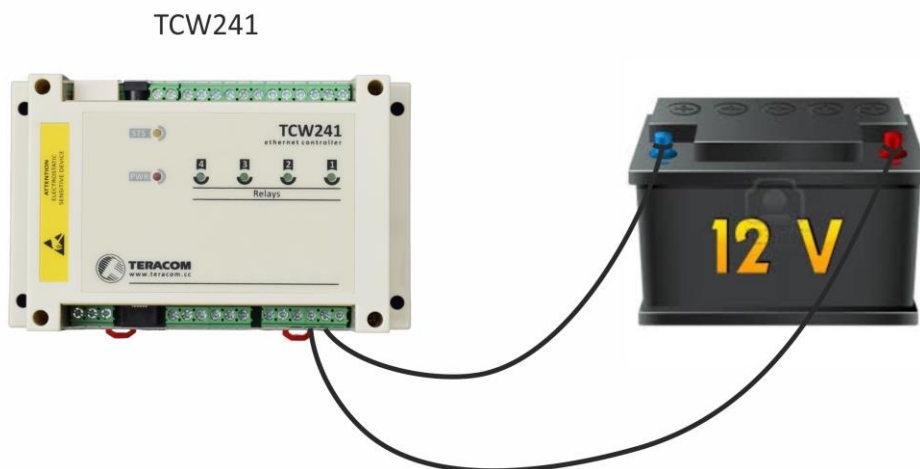

The total cable length should be up to 30 meters.

6.2.4. Sensor connection

Up to 8x1-Wire sensors can be connected to TCW241. The device supports following sensors - temperature, temperature/humidity, CO2, DC current, AC current, 4/20mA, galvanic isolated analog voltage, atmospheric pressure etc. Connected sensors are automatically detected and appropriate dimension is assigned.

1-Wire is a registered trademark of Maxim Integrated Products, Inc. It is designed to connect several sensors over a short wiring. It is not suitable for long distances or environments with EMC interference. We recommend reading Maxim's 1-Wire tips at <http://www.maxim-ic.com/app-notes/index.mvp/id/148>.

The sensors have three wires – positive voltage (+VDD), ground (GND) and bidirectional data (Data). The colors of wires for every sensor are specified in its user manual.

It is strongly recommended to use “daisy chained” (linear topology) for multiple sensors:

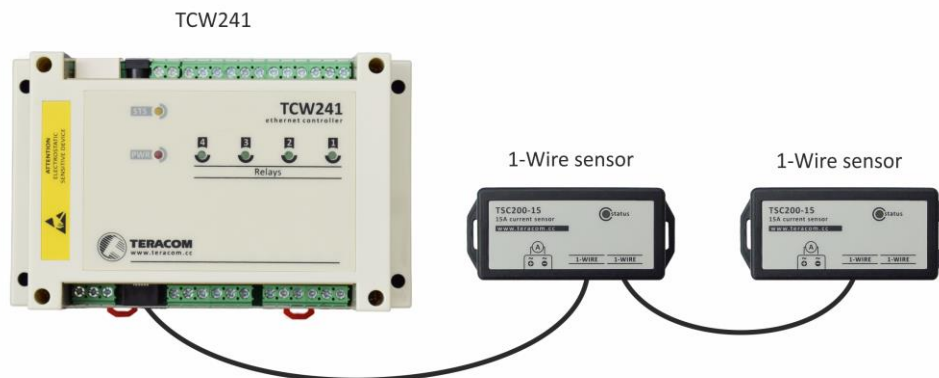

“Star” topology can be used only as a last resort for up to 4 sensors and total cable length up to 10 meters:

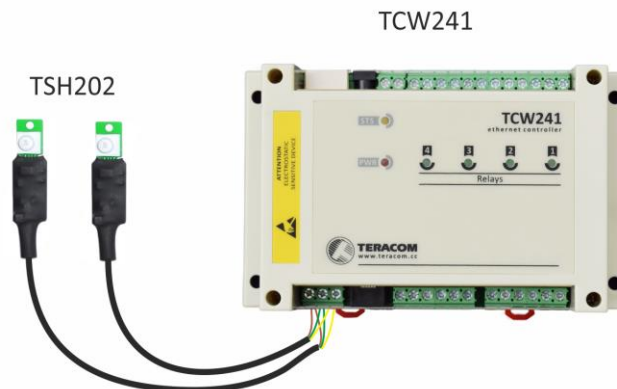

Connections can be realized either by screw terminal connector or by standard RJ-11 connector.

There are many parameters which determine the maximum length of the wires - type of cable, the number of sensors, ambient electromagnetic noise and sensor network topology.

It is strongly recommended to use only UTP/FTP cables and keep total cable length up to 30 m. Although functionality has been achieved in longer distance, we cannot guarantee error-free operation over mentioned wiring length.

We guarantee proper operation only with Teracom 1-Wire sensors.

6.2.5. Relay connection

The relay contacts are internally connected directly to the terminal connectors. For all relays normally open, normally close and common contacts are available.

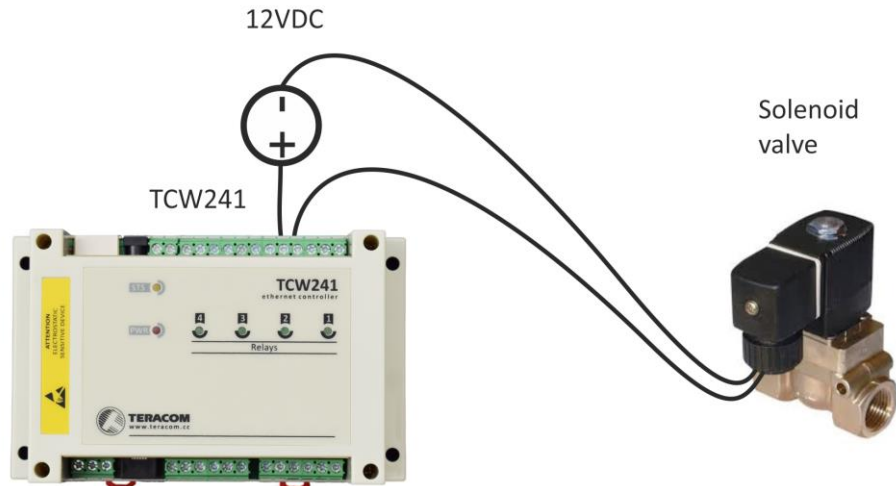

For loads with higher switchable current/voltage than specified, an external relay should be used.

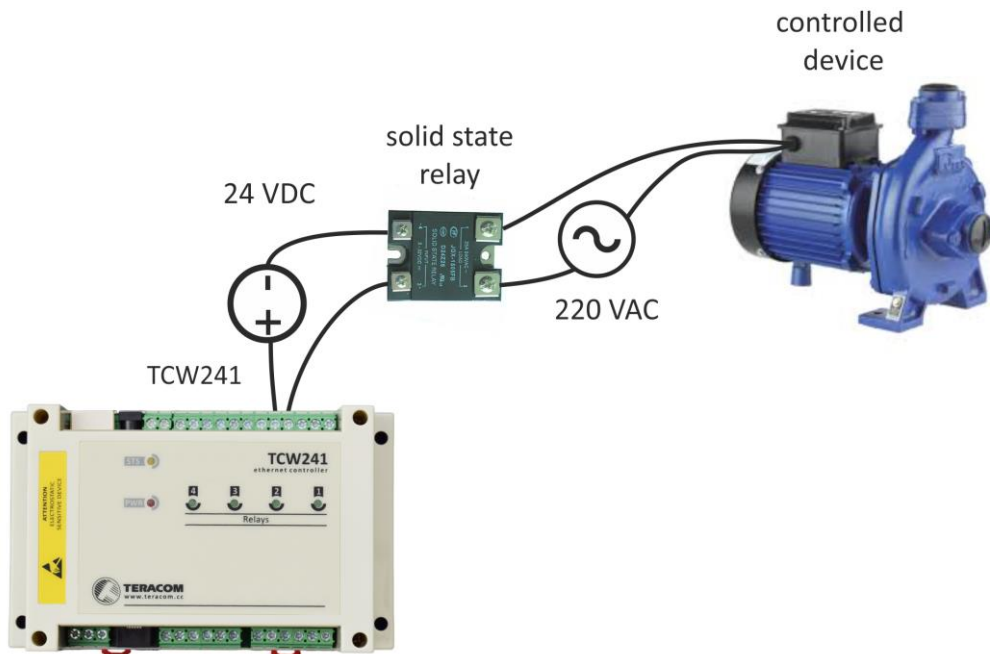

When mechanical relays switch inductive loads such as motors, transformers, relays, etc., the current will arc across the relay contacts each time the contacts open. Over time, this cause wears on the relay contacts which shorten their life. When switching an inductive load, it is recommended that relay contact protection devices are used.

6.2.6. Network connection

The Ethernet port of TCW241 should be connected to 10/100 Base-T Ethernet hub, switch or router.

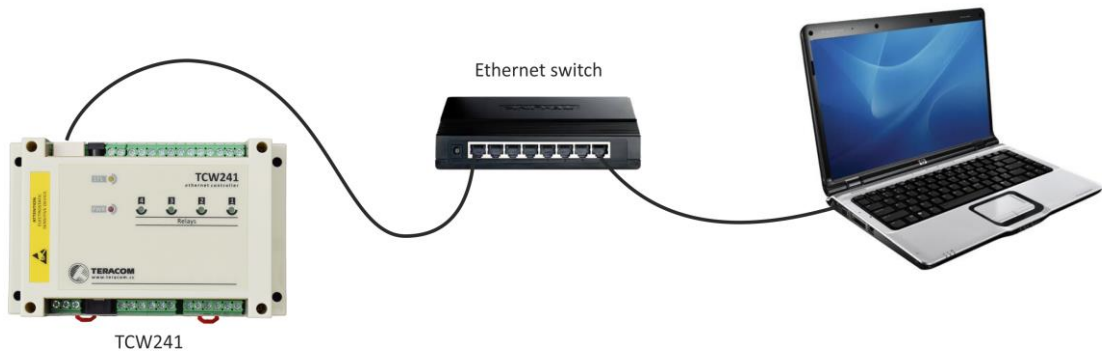

For configuration, **TCW241** may be connected directly to the Ethernet port on a computer. The device support Auto-MDIX and it is not necessary to use “crossover” cable, standard “straight-through” can be also used.



TCW241 can be used in a wireless network by connecting through a wireless router.

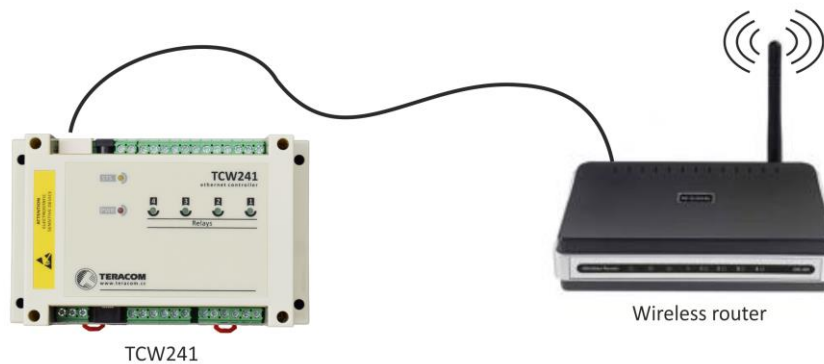

6.3. Communication setup

By default **TCW241** is delivered with the following network settings:

IP address: 192.168.1.2, Subnet Mask: 255.255.255.0, Default Gateway: 192.168.1.1

Communication with **TCW241** can be established by assigning a temporary IP address to the computer. For computers with Windows OS assigning of IP address is made in “Local area connection properties”:

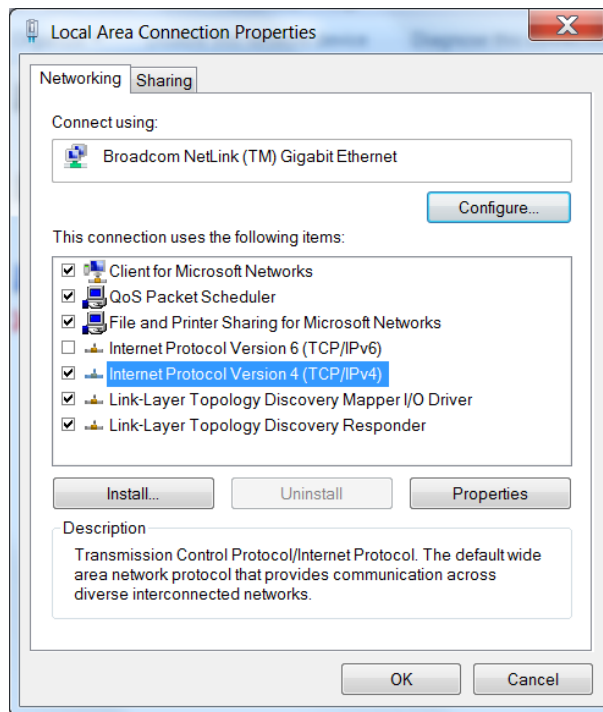

This address should be in the same network - for example 192.168.1.3:

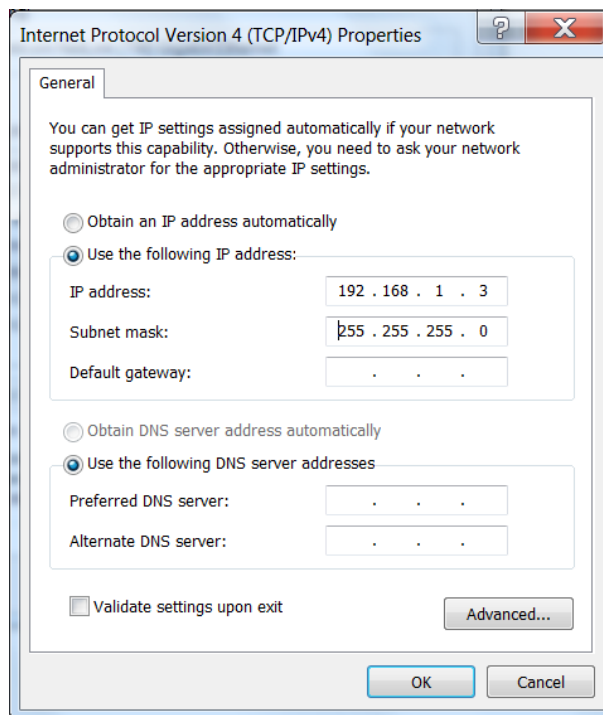

To get access to the web interface, you should type <http://192.168.1.2> into the browser.

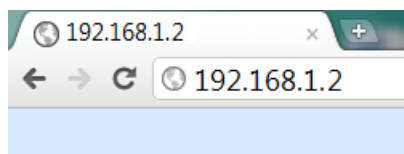

If the network settings are correct, the login pop-up window will appear:

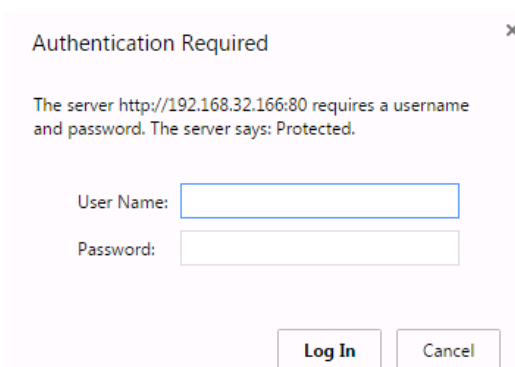

All TCW controllers connected to LAN can be easily found by free tool “TCW discoverer”. It is available for Win and Mac operating systems and can be downloaded from www.teracom.cc

7. Web interface

The web interface allows configuration, monitoring and control.

All pages are UTF-8 encoded.

If the controller is properly addressing, login pop-up window appears.

Authorization data must be entered (by default username=admin, password=admin).

It is recommended to change the username and password to prevent unauthorized access to the controller

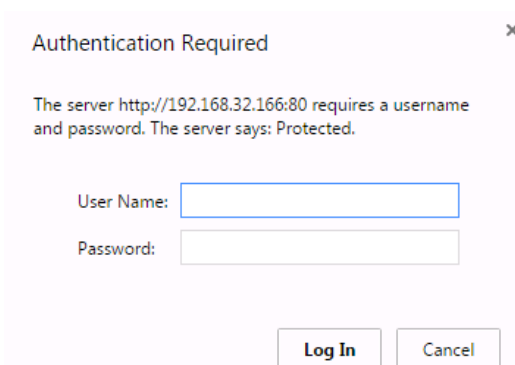

The controller supports a few active session.

7.1. Monitoring page

Monitoring page displays current state of TCW241. There are buttons for relays activation.

The page has 4 sections – “Sensors”, “Digital inputs”, “Analog inputs” and “Relays”. All they can be added/removed from monitoring page independently by appropriate setup - see “Setup-System-Display” section.

For every parameter (sensor, input, relay) there is a description of up to 15 characters. Default ones can be changed in “Setup-Input/Output”.

The Monitoring page can be automatically refreshed on an interval of 0 to 253 seconds. Zero means no automatic refresh. This parameter is set in section “Setup-System-Monitoring page automatic refresh”. By default it is 1 second.

7.1.1. Sensors section

All detected 1-Wire sensors are shown in this section.

Detection is made either after power on or by button “Scan for new sensors”. All found sensors are shown in ascending order refer their unique ID number.

For every sensor there are description, value, and ID information.

Teracom 1-Wire sensors readings are shown in the Value 1 column. Dual sensors such as the (TSH2xx) temperature/humidity sensors have the 2-nd parameter shown on the Value 2 column. It is possible to lock sensors in a specific position. To do this all sensors should be added one by one. After every addition new scan should be made and newly found sensor should be locked in its position. If all sensors are locked, removing one “in the middle” will not change the positions of other sensors after reset. This option is very useful when **TCW241** is used like a part of monitoring and control system managed either by SNMP or HTTP API commands.

For some sensors “Unit”, “Multiplier” and “Offset” can be set in section “Setup-Input/Output”.

Pos	Description	Value 1	Value 2	ID	Lock
1	S1:TST100/1/2/3	23.4 °C	-----	[28FF58896D1404AA]	<input type="checkbox"/>
2	S2:TST100/1/2/3	23.6 °C	-----	[28FFF6AE6F140482]	<input type="checkbox"/>
3	S3:TST100/1/2/3	23.4 °C	-----	[28FF178D6F14046D]	<input type="checkbox"/>
4	S4:TSH201/2/3	22.5 °C	43.0%RH	[01D01FB71700FFF8]	<input type="checkbox"/>
5	S5:TSA	0.0mA	-----	[01383C871600EC5A]	<input type="checkbox"/>
6	S6:TSC	0.0A	-----	[011E15011700FA6E]	<input type="checkbox"/>
7	S7:TSG	790.000ppm	-----	[01671BB71700FE3B]	<input type="checkbox"/>
8	S8:TSV	12.3V	-----	[01AF73871600F26A]	<input type="checkbox"/>

Scan for new sensors

7.1.2. Digital inputs section

Digital inputs can be used for monitoring the state of discrete devices – motion sensor, door contact, relay contact, alarm output etc. All digital inputs are not galvanic isolated.

One side of the contact is connected to “Digital In” and the other side is connected to “GND” pins.

Digital inputs are sampled every 10mS. The change of input status is considered valid if the same value is read in 5 consecutive samples (50mS).

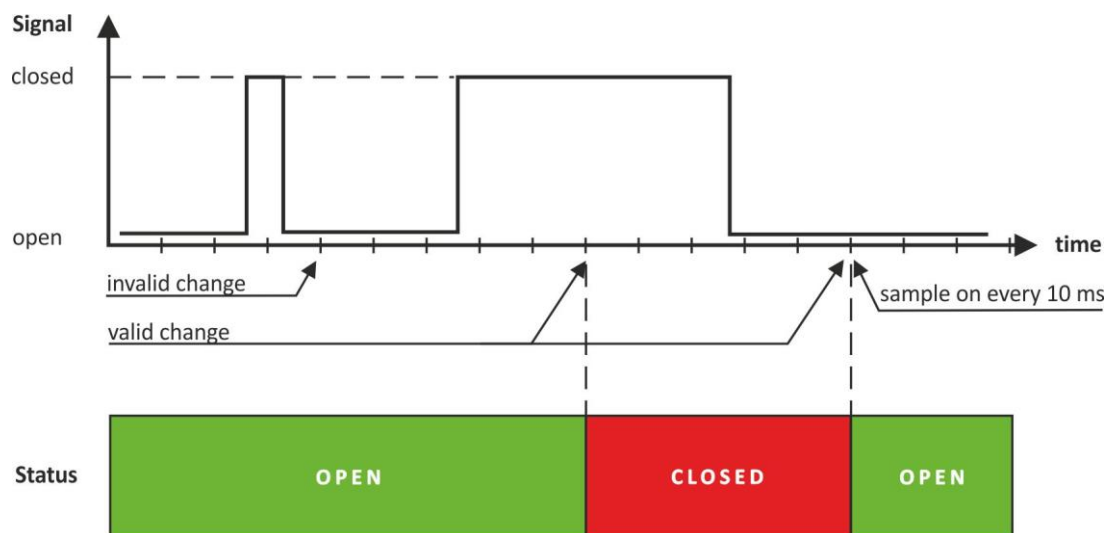

Status of every input is shown by text and by color. The color is red if the input is in alarm condition.

Digital input	Status	Digital input	Status
Digital In1	CLOSED	Digital In2	OPEN
Digital In3	OPEN	Digital In4	CLOSED

Default descriptions can be changed in “Setup-Input/Output”.

7.1.3. Analog inputs section

Analog inputs can be used for monitoring of analog sensors with 0-5 or 0-10 voltage outputs.

All analog inputs are not galvanic isolated.

One side of source is connected to “Analog In” and the other side is connected to “GND” pins.

Analog input	Value	Analog input	Value
Analog Input 1	5.00V	Analog Input 2	12.22V
Analog Input 3	4.99V	Analog Input 4	12.23V

For every analog input 3 variables – “Unit”, “Multiplier” and “Offset” can be set in section “Setup-Input/Output”.

7.1.4. Relay section

The section displays the current state of relays and presents buttons that can be used to change their status.

Relay	Status	Control
Relay 1	OFF	automatically controlled by S1:TST100/1/2/3 Temperature
Relay 2	ON	<input type="button" value="ON"/> <input type="button" value="OFF"/> <input type="button" value="Pulse"/>
Relay 3	OFF	<input type="button" value="ON"/> <input type="button" value="OFF"/> <input type="button" value="Pulse"/>
Relay 4	OFF	<input type="button" value="ON"/> <input type="button" value="OFF"/> <input type="button" value="Pulse"/>
		<input type="button" value="All On"/> <input type="button" value="All Off"/> <input type="button" value="Pulse All"/>

Each relay can be activated either remotely by the WEB interface, HTTP API and SNMP or locally, from the status of a monitored parameter (1 Wire sensor, analog voltage and dry contact).

Locally relay can be controlled either by one parameter or by “any alarm” condition.

For WEB control every relay has “On”, “Off” and “Pulse” buttons. There are also “All On”, “All Off” and “Pulse All” for common control of relays. Pulse duration in seconds can be set separately for each relay in “Setup-Input/Output-Relay Outputs”.

For locally activated relays a text description of the controlling parameter is displayed rather than buttons. Parameters for local relay activation can be set in “Setup-Input/Output-Relay Outputs”. Control of relays follows conditions set in “Setup-Alarm conditions”.

7.2. Setup page

7.2.1. Network

The network parameters are set in this section.

Network Setup	
Host name	<input type="text" value="TCW241"/>
Static/DHCP	<input type="text" value="Static"/>
IP address	<input type="text" value="192.168.32.167"/>
Subnet mask	<input type="text" value="255.255.255.0"/>
Default gateway	<input type="text" value="192.168.32.1"/>
DNS	<input type="text" value="192.168.32.1"/>
MAC Address	D8-80-39-35-55-22

The controller supports static and dynamic IP addresses.

It is good practice to change the default IP address of controller immediately after first power-on.

This will avoid collisions if many devices are used in the same network.

It may be necessary to clear the arp cache, each time you connect a new device to the network. This is done by typing `arp -d` in the command prompt window of computer. The "Host name" is up to 15 characters. It is shown in search results of TCW discoverer.

7.2.2. SMTP

This page is used to enter valid SMTP settings for email alerts and recipients' addresses.

7.2.2.1. SMTP setup

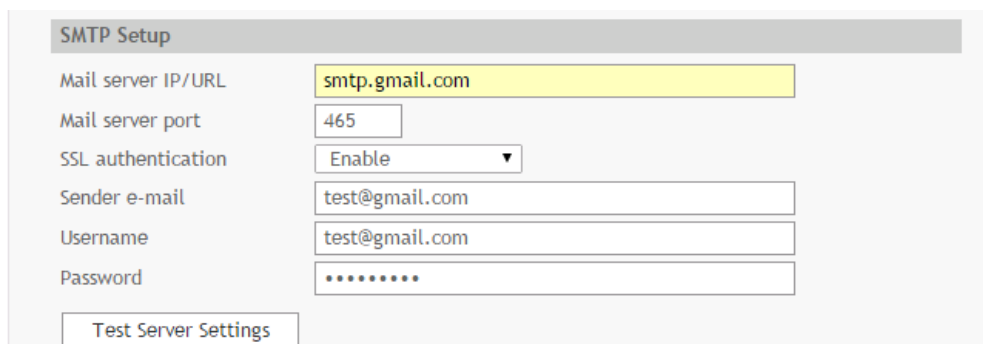

Mail server IP/URL	smtp.gmail.com
Mail server port	465
SSL authentication	Enable
Sender e-mail	test@gmail.com
Username	test@gmail.com
Password

Test Server Settings

Mail server address can be set either by host name (www.gmail.com) or IP address. By default, without SSL authorization, SMTP port is 25. Ask ISP if default port doesn't work. SSL is used for security authorization for some public mail servers like gmail. Sender e-mail, user name and password are standard authentication details. For most SMTP servers sender e-mail and user name are the same. There is a button for server settings test with a feedback. In this test sender and recipient of e-mail is the same.

7.2.2.2. Alarm destination

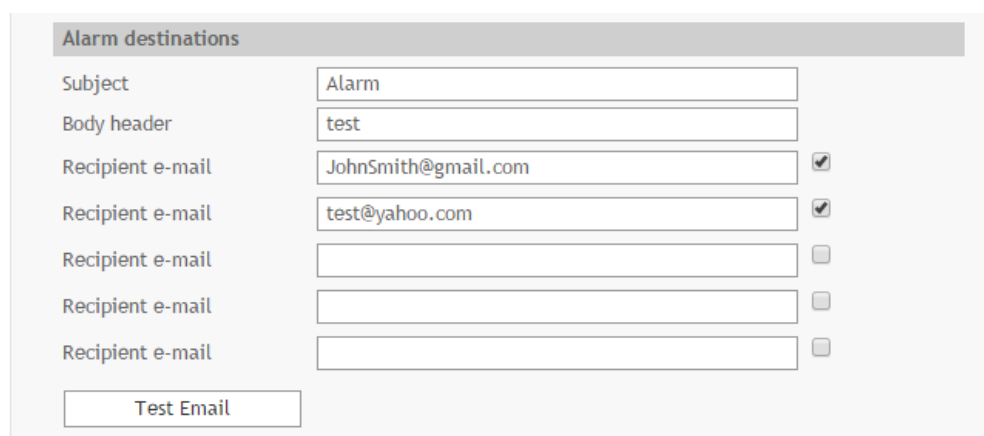

Subject	Alarm	
Body header	test	
Recipient e-mail	JohnSmith@gmail.com	<input checked="" type="checkbox"/>
Recipient e-mail	test@yahoo.com	<input checked="" type="checkbox"/>
Recipient e-mail		<input type="checkbox"/>
Recipient e-mail		<input type="checkbox"/>
Recipient e-mail		<input type="checkbox"/>

Test Email

Alarm e-mails can be send on up to 5 recipients. All they can be activated independently by check box.

Header and body of these e-mails are user defined. Both field can consist of 36 characters. There is a button for test e-mail. There is no feedback form this test. All recipients' mail boxes should be checked manually for available e-mail.

7.2.3. Input/Output

7.2.3.1. 1-Wire sensors

For every 1-Wire sensor up to 15 characters description can be set.

For all sensors “Offset” field is enabled. Number from this field is used for simple correction of displayed value.

For some specific sensor, like TSA200, TSV200 etc., fields “Unit” and “Multiplier” are also available.

Sensors				
Sensor #	Description	Unit	Multiplier	Offset
S1	S1:TST100/1/2/3	°C	1.000	0.00

S2	S2:TST100/1/2/3	°C	1.000	0.00

S3	S3:TST100/1/2/3	°C	1.000	0.00

S4	S4:TSH201/2/3	°C	1.000	0.00
		%RH	1.000	0.00
S5	S5:TSA	mA	1.000	0.00

S6	S6:TSC	A	1.000	0.00

S7	S7:TSG	ppm	1.000	0.0000

S8	S8:TSV	V	1.000	0.00

7.2.3.2. Digital inputs

For every digital input up to 15 characters description can be set.

Text written in “Low level” and “High level” is displayed on monitoring page for this input.

These field accept up to 15 characters.

Digital inputs				
Input #	Description	Low level	High level	
DI1	Digital Input 1	CLOSED	OPEN	
DI2	Digital Input 2	CLOSED	OPEN	
DI3	Digital Input 3	CLOSED	OPEN	
DI4	Digital Input 4	CLOSED	OPEN	

7.2.3.3. Analog inputs

For every analog input up to 15 characters description can be set.

Analog inputs				
Input #	Description	Unit	Multiplier	Offset
A11	Server room	%RH	31.740	0.8260
A12	Analog Input 2	V	1.000	0.000
A13	Analog Input 3	V	1.000	0.000
A14	Analog Input 4	V	1.000	0.000

For every analog input fields “Unit”, “Multiplier” and “Offset” are available. They can be used to convert the raw voltage input to meaningful engineering units if required. The shown value is calculated by:

$$DV[Un] = (AV - OF) * MU$$

Where:

DV – displayed value;

Un – unit;

AV – real analog voltage from source;

MU – multiplier in dimension [parameter/Volt];

OF – offset.

Example:

For humidity sensor HIH-4000-003 following parameter (coming from data sheet) should be set for fine work:

Unit - %RH

Offset - 0.826

Multiplier - 31.74, the value is inversed of slope parameter (1/0.0315);

If the output voltage of this sensor is 3.198V on the monitoring page will be shown 75.28% RH:

$$75.28 = (3.198 - 0.826) * 31.74$$

By default and after “Factory default settings” procedure:

Unit - V

Offset - 0.00

Multiplier - 1.00

7.2.3.4. Relay outputs

For every relay up to 15 characters description can be set.

Relay outputs			
Relay #	Description	Pulse (seconds)	Activated from
R1	Heater	1	S1:TST100/1, ▼
R2	Boiler	2	manual ▼
R3	Relay 3	1	manual ▼
R4	Relay 4	1	manual ▼

For every relay different time for pulse duration can be set. The resolution is 1 second.

Every relay can be activated remotely or locally – by value of monitored parameter.

By default all relays are activated remotely, by WEB interface and in field “Activated from” is written “manual”.

For local activation, alarm conditions for different sources are used. They are set up in section “Setup-Alarm conditions”. To assign parameter to relay, following choices are possible:

- Sxy – “S” stands for “Sensor 1-Wire”, “x” is number from 1 to 8, “y” is number from 1 to 2. The relay is activated from value measured from specified 1-Wire sensor and rules for ranges specified in “Setup-Alarm conditions”;
- “Analog input ?” - the relay is activated from value measured from specified analog input and rules for ranges specified in “Setup-Alarm conditions”. Question mark masks number from 1 to 2;
- “Digital input ?” - the relay follows the state of specified digital input. Question mark masks number from 1 to 2;
- Any alarm - the relay is activated from any of set alarm conditions.

7.2.4. Conditions

This section is used for parameterization of trigger and alert conditions for 1-Wire sensors, analog and digital inputs.

7.2.4.1. 1-Wire sensors and analog inputs

For every sensor two type of fields are presented – one for set of trigger conditions (“Min”, “Max” and “Hys.”) and other one for e-mail alert (“If out of range”).

Sensors						If out of range		
#	Description	Type	Min.	Max.	Hys.	mail	trap	post
1	S1:TST100/1/2/3	Temperature, °C	15.0	21.0	0.5	<input checked="" type="checkbox"/>	<input checked="" type="checkbox"/>	<input checked="" type="checkbox"/>
		---	---	---	---	<input type="checkbox"/>	<input type="checkbox"/>	<input type="checkbox"/>
2	S2:TST100/1/2/3	Temperature, °C	-40.0	85.0	0.5	<input checked="" type="checkbox"/>	<input checked="" type="checkbox"/>	<input checked="" type="checkbox"/>
		---	---	---	---	<input type="checkbox"/>	<input type="checkbox"/>	<input type="checkbox"/>
3	S3:TST100/1/2/3	Temperature, °C	-40.0	85.0	0.5	<input checked="" type="checkbox"/>	<input checked="" type="checkbox"/>	<input checked="" type="checkbox"/>
		---	---	---	---	<input type="checkbox"/>	<input type="checkbox"/>	<input type="checkbox"/>
4	S4:TST100/1/2/3	Temperature, °C	-40.0	85.0	0.5	<input checked="" type="checkbox"/>	<input checked="" type="checkbox"/>	<input checked="" type="checkbox"/>
		---	---	---	---	<input type="checkbox"/>	<input type="checkbox"/>	<input type="checkbox"/>
5	S5:TST100/1/2/3	Temperature, °C	-40.0	85.0	0.5	<input checked="" type="checkbox"/>	<input checked="" type="checkbox"/>	<input checked="" type="checkbox"/>
		---	---	---	---	<input type="checkbox"/>	<input type="checkbox"/>	<input type="checkbox"/>
6	S6:TST100/1/2/3	Temperature, °C	-40.0	85.0	0.5	<input checked="" type="checkbox"/>	<input checked="" type="checkbox"/>	<input checked="" type="checkbox"/>
		---	---	---	---	<input type="checkbox"/>	<input type="checkbox"/>	<input type="checkbox"/>
7	S7:TST100/1/2/3	Temperature, °C	-40.0	85.0	0.5	<input checked="" type="checkbox"/>	<input checked="" type="checkbox"/>	<input checked="" type="checkbox"/>
		---	---	---	---	<input type="checkbox"/>	<input type="checkbox"/>	<input type="checkbox"/>
8	S8:TST100/1/2/3	Temperature, °C	-40.0	85.0	0.5	<input checked="" type="checkbox"/>	<input checked="" type="checkbox"/>	<input checked="" type="checkbox"/>
		---	---	---	---	<input type="checkbox"/>	<input type="checkbox"/>	<input type="checkbox"/>
Return notification		<input checked="" type="checkbox"/>	Notification delay (seconds)		5	(0-3600)		
Analog inputs						If out of range		
#	Description	Dimension	Min.	Max.	Hys.	mail	trap	post
1	Analog Input 1	V	4.50	5.50	0.10	<input checked="" type="checkbox"/>	<input type="checkbox"/>	<input type="checkbox"/>
2	Analog Input 2	V	11.00	13.00	0.20	<input checked="" type="checkbox"/>	<input type="checkbox"/>	<input type="checkbox"/>
3	Analog Input 3	V	0.00	60.00	1.00	<input checked="" type="checkbox"/>	<input type="checkbox"/>	<input type="checkbox"/>
4	Analog Input 4	V	0.00	60.00	1.00	<input checked="" type="checkbox"/>	<input type="checkbox"/>	<input type="checkbox"/>
Return notification		<input checked="" type="checkbox"/>	Notification delay (seconds)		3	(0-3600)		

“Min” and “Max” indicate border of working range for observed parameter.

A “Max” trigger condition occurs when the value exceeds the trigger set point. A “Min” trigger condition occurs when the value is lower than the trigger set point. In both cases the monitored parameter goes out of range.

Coming back in range for observed parameter is considered when the value goes higher than (Min + Hys) or lower than (Max – Hys). Hysteresis (“Hys”) is used to prevent from excessively triggering when the value vacillates around trigger point.

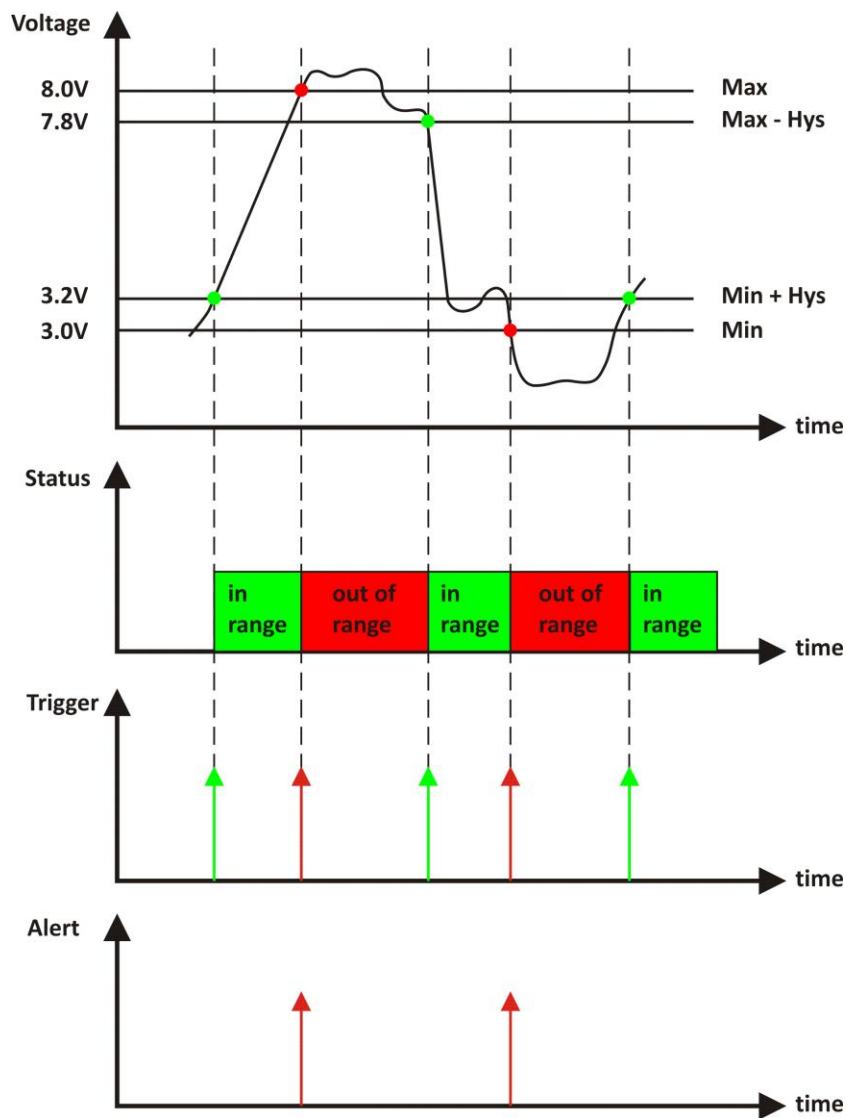

Example:

TCW241, TST100 and appropriate heater are used to control the room temperature. The wanted minimum temperature is 19°C. The initial temperature is 17°C.

TST100 is assigned on the first position for 1-Wire sensors.

For Relay1 local activation from Sensor1 is set.

Following parameters are set for Sensor1: Min=19, Max=85 and Hys=0.5.

Sensors						If out of range		
#	Description	Type	Min.	Max.	Hys.	mail	trap	post
1	S1:TST100/1/2/3	Temperature, °C	19	85.0	0.5	<input checked="" type="checkbox"/>	<input checked="" type="checkbox"/>	<input checked="" type="checkbox"/>

When the controller is switched on, Relay1 is immediately activated because the monitored temperature is out of range. This switches the heater on. The temperature is going higher.

When temperature reaches 19.5°C (19.0 + 0.5) it goes in range (trigger condition) and Relay1 is deactivated. The heater is switched off.

The temperature falls and when it reached 19°C it goes out of range (trigger and alert conditions). The relay is activated (heater is switched on) and e-mail is sent.

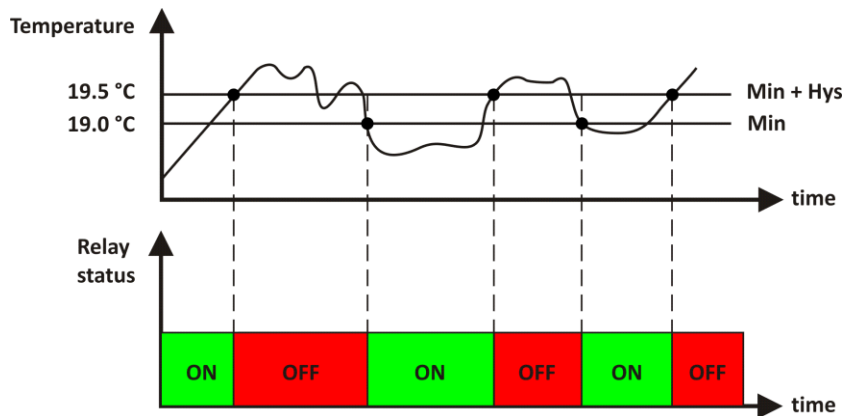

The “Max” value is set far enough from the wanted temperature to avoid trigger/alert conditions around it.

For every sensor or analog input there are 3 independent way of alert when there is an alarm condition – e-mail, SNMP trap and push (HTTP post of XML file). Each alarm notification method is activated by check box.

Globally for all sensors and for all analog inputs there are check box “Return notification”. If this option is chosen there will be notification also when parameter returns in range.

Globally for all sensors and for all analog inputs there are “Notification delay” parameter. It is very useful like a filter for short alarm conditions.

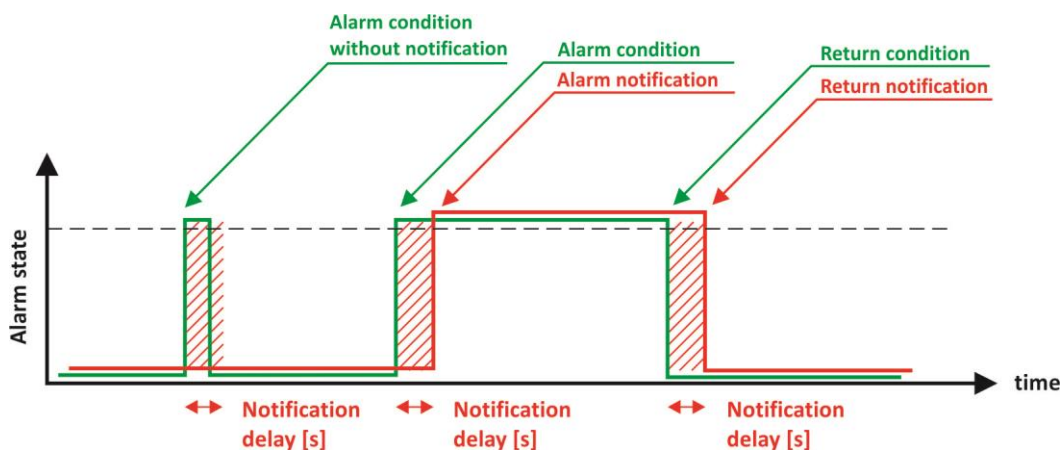

7.2.4.2. Digital inputs

For every digital inputs alarm state is chosen – Open or Close. When the input goes in alarm state 3 independent way of alert are possible – e-mail, SNMP trap and push (HTTP post of XML file).

In the time when the input is in alarm state, on Monitoring page appropriate input will be colored in red.

Digital inputs				On active alarm		
#	Description	Current state	Select alarm state	mail	trap	post
1	Digital Input 1	CLOSED	OPEN	<input checked="" type="checkbox"/>	<input type="checkbox"/>	<input type="checkbox"/>
2	Digital Input 2	OPEN	CLOSED	<input checked="" type="checkbox"/>	<input type="checkbox"/>	<input type="checkbox"/>
3	Digital Input 3	OPEN	CLOSED	<input checked="" type="checkbox"/>	<input type="checkbox"/>	<input type="checkbox"/>
4	Digital Input 4	OPEN	CLOSED	<input checked="" type="checkbox"/>	<input type="checkbox"/>	<input type="checkbox"/>
Return notification		<input checked="" type="checkbox"/>	Notification delay (seconds)	1	(0-3600)	

Globally for all digital inputs there is a check box “Return notification”. If this option is chosen there will be notification also when parameter returns in range.

Globally for all digital inputs there is “Notification delay” parameter. It is very useful like a filter for short alarm conditions.

7.2.5. System

On this page some general settings can be made.

7.2.5.1. General

In this section some general parameter for identification of device can be set.

General	
System name	<input type="text" value="Name"/>
System location	<input type="text" value="Location"/>
System contact	<input type="text" value="info@teracom.cc"/>

7.2.5.2. WEB access

In this section WEB access authentication can be deactivated. By default it is activated with admin/admin authentication details.

HTTP port for WEB access can be changed. This is useful for some routers which don't support different outside/inside ports for port forwarding. By default HTTP port is 80.

Web access	
Authentication	<input type="text" value="Enabled"/>
HTTP port	<input type="text" value="80"/>

7.2.5.3. HTTP API

In this section HTTP API access authentication can be activated/deactivated. By default it is active.

XML/HTTP API	
Authentication	<input type="text" value="Enabled"/>

Authentication details are same like WEB access. The controller support two types of authentication – see explanation for HTTP API below.

7.2.5.4. Monitoring page automatic refresh

Monitoring page refresh interval can be set between 0 and 253 seconds. Zero means no automatic refresh.

Monitoring page automatic refresh	
Interval (seconds)	<input type="text" value="1"/> (0-253)

7.2.5.5. Display

The unit for observed temperatures can be selected between Celsius and Fahrenheit temperature scales.

All four sections on “Monitoring page” can be added or removed independently by appropriate setup here.

Temperature Units	<input type="text" value="Celsius"/>	Sensors	<input checked="" type="checkbox"/>
		Digital Inputs	<input checked="" type="checkbox"/>
		Analog Inputs	<input checked="" type="checkbox"/>
		Relay Outputs	<input checked="" type="checkbox"/>

7.2.6. NTP

Internal RTC (Real Time clock) of controller can be set either manually or automatically.

Time configuration	NTP Server
NTP server IP/URL	pool.ntp.org
Time zone	+2.00
Interval (h)	12
If not found (h)	1
Set time	30.11.2015,06:33:42

SAVE

Current time	30.11.2015,08:33:55
Last updated	30.11.2015,08:33:43
Status	OK
Delay (ms)	11.6mS
Stratum	2

For automatic clock synchronization, the controller supports NTP (Network Time Protocol) and all necessary parameters for automatic synchronization are available in this section. By default NTP synchronization is enabled, server – pool.ntp.org, Time zone +2 and interval of 12 hours.

7.3. Services

7.3.1. Modbus

TCW241 supports Modbus/TCP.

Modbus	Enable
Port	502

By default Modbus is disabled. Standard port for this protocol is 502.

7.3.2. SNMP

The TCW241 supports SNMP v.2. This enables the device to be part of monitoring and control systems over SNMP protocol.

In this section all necessary parameters for proper operation of SNMP can be set.

SNMP	Enable	SNMP port	161
		Read community	public
		Write community	private

IP	192.168.32.30	Port	162	Community	public	Enable	Trap test
IP	0.0.0.0	Port	162	Community	public	Disable	Trap test
IP	0.0.0.0	Port	162	Community	public	Disable	Trap test
IP	0.0.0.0	Port	162	Community	public	Disable	Trap test
IP	0.0.0.0	Port	162	Community	public	Disable	Trap test

Download MIB File

By default SNMP is disabled, port is 161, read community is public and write community is private.

In alarm condition SNMP trap can be send up to 5 independent recipients. All they can be with different port and community. There is independent button for trap test.

SNMP traps can be sent if:

- event occurs (status change) on Digital Inputs;
- measured parameter on Analog Inputs goes outside the range;
- measured parameter on 1-Wire bus goes outside the range;
- restart condition;

SNMP trap is sent after reset.

Actual MIB file can be downloaded from here.

All changed **information** in above sections is saved with button “Save”.

7.3.3. HTTP post

TCW241 can periodically upload file to dedicated server, using HTTP Post. The post period is between 10 and 3600 seconds. The file format can be XML or JSON.

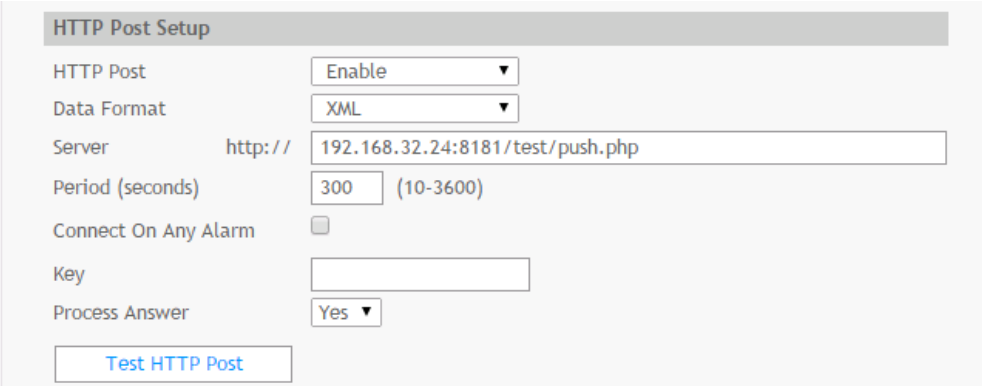

The screenshot shows the 'HTTP Post Setup' configuration window. It contains the following fields and controls:

- HTTP Post:** A dropdown menu set to 'Enable'.
- Data Format:** A dropdown menu set to 'XML'.
- Server:** A text input field containing 'http://192.168.32.24:8181/test/push.php'.
- Period (seconds):** A numeric input field set to '300', with a range '(10-3600)' indicated to its right.
- Connect On Any Alarm:** An unchecked checkbox.
- Key:** An empty text input field.
- Process Answer:** A dropdown menu set to 'Yes'.
- Test HTTP Post:** A blue button at the bottom of the form.

In addition to periodically post, file can be uploaded at any alarm condition. In this case “Connect on any alarm” should be checked.

The “Key” field value is sent in the XML/JSON and can be used for device identification.

If “Process Answer” option is enabled, the **TCW241** will process the answer of the remote server.

List of valid commands are described in section “HTTP API commands”

7.3.4. Schedule

TCW241 supports four schedules. In every schedule up to four different tasks can be set.

The schedules are useful for creating tasks that vary with calendar dates. It is possible to combine two relays in control of one device - one relay follows monitored parameter and other follows schedule. In this case more complex control can be arranged.

Machine 1											
Mode	Date	M	T	W	T	F	S	S	Type	ON	OFF
Once	12.01.2016	<input type="checkbox"/>	<input type="checkbox"/>	<input type="checkbox"/>	<input type="checkbox"/>	<input type="checkbox"/>	<input type="checkbox"/>	<input type="checkbox"/>	On/Off	10:19:00	10:20:00
Once	12.01.2016	<input type="checkbox"/>	<input type="checkbox"/>	<input type="checkbox"/>	<input type="checkbox"/>	<input type="checkbox"/>	<input type="checkbox"/>	<input type="checkbox"/>	Pulse	13:00:00	00:00:00
Weekly	04.01.2016	<input checked="" type="checkbox"/>	<input checked="" type="checkbox"/>	<input checked="" type="checkbox"/>	<input checked="" type="checkbox"/>	<input checked="" type="checkbox"/>	<input type="checkbox"/>	<input type="checkbox"/>	On/Off	08:00:00	17:00:00
Weekly	04.01.2016	<input type="checkbox"/>	<input type="checkbox"/>	<input type="checkbox"/>	<input type="checkbox"/>	<input type="checkbox"/>	<input checked="" type="checkbox"/>	<input checked="" type="checkbox"/>	Pulse	12:00:00	00:00:00

Schedule 2											
Mode	Date	M	T	W	T	F	S	S	Type	ON	OFF
Disabled	01.01.1900	<input type="checkbox"/>	<input type="checkbox"/>	<input type="checkbox"/>	<input type="checkbox"/>	<input type="checkbox"/>	<input type="checkbox"/>	<input type="checkbox"/>	On/Off	00:00:00	00:00:00
Disabled	01.01.1900	<input type="checkbox"/>	<input type="checkbox"/>	<input type="checkbox"/>	<input type="checkbox"/>	<input type="checkbox"/>	<input type="checkbox"/>	<input type="checkbox"/>	On/Off	00:00:00	00:00:00
Disabled	01.01.1900	<input type="checkbox"/>	<input type="checkbox"/>	<input type="checkbox"/>	<input type="checkbox"/>	<input type="checkbox"/>	<input type="checkbox"/>	<input type="checkbox"/>	On/Off	00:00:00	00:00:00
Disabled	01.01.1900	<input type="checkbox"/>	<input type="checkbox"/>	<input type="checkbox"/>	<input type="checkbox"/>	<input type="checkbox"/>	<input type="checkbox"/>	<input type="checkbox"/>	On/Off	00:00:00	00:00:00

Schedule 3											
Mode	Date	M	T	W	T	F	S	S	Type	ON	OFF
Disabled	01.01.1900	<input type="checkbox"/>	<input type="checkbox"/>	<input type="checkbox"/>	<input type="checkbox"/>	<input type="checkbox"/>	<input type="checkbox"/>	<input type="checkbox"/>	On/Off	00:00:00	00:00:00
Disabled	01.01.1900	<input type="checkbox"/>	<input type="checkbox"/>	<input type="checkbox"/>	<input type="checkbox"/>	<input type="checkbox"/>	<input type="checkbox"/>	<input type="checkbox"/>	On/Off	00:00:00	00:00:00
Disabled	01.01.1900	<input type="checkbox"/>	<input type="checkbox"/>	<input type="checkbox"/>	<input type="checkbox"/>	<input type="checkbox"/>	<input type="checkbox"/>	<input type="checkbox"/>	On/Off	00:00:00	00:00:00
Disabled	01.01.1900	<input type="checkbox"/>	<input type="checkbox"/>	<input type="checkbox"/>	<input type="checkbox"/>	<input type="checkbox"/>	<input type="checkbox"/>	<input type="checkbox"/>	On/Off	00:00:00	00:00:00

Schedule 4											
Mode	Date	M	T	W	T	F	S	S	Type	ON	OFF
Disabled	01.01.1900	<input type="checkbox"/>	<input type="checkbox"/>	<input type="checkbox"/>	<input type="checkbox"/>	<input type="checkbox"/>	<input type="checkbox"/>	<input type="checkbox"/>	On/Off	00:00:00	00:00:00
Disabled	01.01.1900	<input type="checkbox"/>	<input type="checkbox"/>	<input type="checkbox"/>	<input type="checkbox"/>	<input type="checkbox"/>	<input type="checkbox"/>	<input type="checkbox"/>	On/Off	00:00:00	00:00:00
Disabled	01.01.1900	<input type="checkbox"/>	<input type="checkbox"/>	<input type="checkbox"/>	<input type="checkbox"/>	<input type="checkbox"/>	<input type="checkbox"/>	<input type="checkbox"/>	On/Off	00:00:00	00:00:00
Disabled	01.01.1900	<input type="checkbox"/>	<input type="checkbox"/>	<input type="checkbox"/>	<input type="checkbox"/>	<input type="checkbox"/>	<input type="checkbox"/>	<input type="checkbox"/>	On/Off	00:00:00	00:00:00

SAVE

There are four type of schedule depending of repetition and duration:

- Single task for time period:

Once	12.01.2016	<input type="checkbox"/>	<input type="checkbox"/>	<input type="checkbox"/>	<input type="checkbox"/>	<input type="checkbox"/>	<input type="checkbox"/>	<input type="checkbox"/>	On/Off	10:19:00	10:20:00
------	------------	--------------------------	--------------------------	--------------------------	--------------------------	--------------------------	--------------------------	--------------------------	--------	----------	----------

With above setting there will be event on 1.1.2014 starts in 00:00 and ends in 00:01.

- Single pulse task:

Once	12.01.2016	<input type="checkbox"/>	<input type="checkbox"/>	<input type="checkbox"/>	<input type="checkbox"/>	<input type="checkbox"/>	<input type="checkbox"/>	<input type="checkbox"/>	Pulse	13:00:00	00:00:00
------	------------	--------------------------	--------------------------	--------------------------	--------------------------	--------------------------	--------------------------	--------------------------	-------	----------	----------

With above setting there will be pulse event on 1.1.2014 in 13:00:00. The pulse duration is depends of chosen relay's setting – section "Setup-Inputs/Outputs-Relay outputs".

- Weekly task for time period:

Weekly	04.01.2016	<input checked="" type="checkbox"/>	<input checked="" type="checkbox"/>	<input checked="" type="checkbox"/>	<input checked="" type="checkbox"/>	<input checked="" type="checkbox"/>	<input type="checkbox"/>	<input type="checkbox"/>	On/Off	08:00:00	17:00:00
--------	------------	-------------------------------------	-------------------------------------	-------------------------------------	-------------------------------------	-------------------------------------	--------------------------	--------------------------	--------	----------	----------

With above setting there will be event every working day of the week starts in 08:00 and ends in 17:00.

- Weekly pulse task:

Weekly	04.01.2016	<input type="checkbox"/>	<input type="checkbox"/>	<input type="checkbox"/>	<input type="checkbox"/>	<input type="checkbox"/>	<input checked="" type="checkbox"/>	<input checked="" type="checkbox"/>	Pulse	12:00:00	00:00:00
--------	------------	--------------------------	--------------------------	--------------------------	--------------------------	--------------------------	-------------------------------------	-------------------------------------	-------	----------	----------

With above setting there will be pulse event every Saturday and Sunday 12:00:00. The pulse duration can be set in section "Setup-Inputs/Outputs-Relay outputs". All changed information in above sections is saved with button "Save".

7.3.5. Functions.

In this section four independent function can be arranged. In every function up to four monitored parameters can be logical combined with AND and OR operators. The brackets determine the order of execution.

These functions are available in drop down menu for local relays activation.

The screenshot shows a configuration interface for four functions. Each function is represented by a horizontal bar with a title (Function 1 to Function 4). Below each bar is a sequence of dropdown menus enclosed in parentheses, representing logical combinations of parameters. For example, Function 1 shows 'S1:TST1' followed by 'OR', 'Analog I', 'OR', and several empty dropdowns. A 'SAVE' button is located at the bottom of the interface.

7.4. Administration

7.4.1. User/Pass

The TCW241 supports one user only. It has administrative rights.

The user and password can be up to 31 characters long.

The screenshot shows the 'Web access' configuration section. It contains three input fields: 'Username' with the value 'admin', 'Password' with masked characters '*****', and 'Confirm Password' also with masked characters '*****'. A blue border highlights the 'Confirm Password' field.

7.4.2. Backup/Restore

The TCW241 supports backup and restore of all user setting. All settings are saved in XML backup file. This file can be used after this for restore on many devices. This is very useful for multiply similar settings to batch of controllers.

The screenshot shows the 'Backup/Restore Configuration' section. It features a 'Select configuration file' label, a 'Choose File' button, and a text box containing 'No file chosen'. Below these are two buttons: 'RESTORE' and 'BACKUP'.

7.4.3. FW update

The TCW241 can be updated via WEB interface.

The screenshot shows the 'Firmware update' section. It displays 'Current FW version' as 'v0.17'. Below it is a 'Select FW version' label, a 'Choose File' button, and a text box containing 'No file chosen'. An 'UPLOAD' button is located at the bottom.

To update the device follow the steps below:

- Go to www.teracom.cc and download the latest firmware;
- From **Administration->FW update** select downloaded .cod file and press “upload” button;
- After the firmware update is completed, Login page will appears.

Attention! Don't turn off the power supply during the update. Turning off the power supply will damage the device.

7.5. Logout

The **TCW241** support multisession, but the good practice is to logout after finish the work.

8. Protocols and API

8.1. SNMP

Simple Network Management Protocol (SNMP) is a standard internet protocol for managing devices on IP networks. In typical uses of SNMP, one or more administrative computers, called managers, monitor and control devices on LAN. Each controlled device, at all times, executes a software component called an agent which reports information via SNMP to the manager.

The **TCW241** can be configured and monitored through SNMP.

This could be done using every SNMP v.2 compatible program. Parameters that can be changed, are grouped according to their functions in the tables below. To obtain a valid OID number it is necessary to replace the “x” symbol with “1.3.6.1.4.1.38783”.

To save the changes **configurationSaved** (OID x.2.3.5.0) should be set to “1”.

product

OID	Name	Access	Description	Syntax
x.3.1.1.0	name	read-only	Device name	DisplayString
x.3.1.2.0	version	read-only	Firmware version	DisplayString
x.3.1.3.0	date	read-only	Release date	DisplayString

setup -> network

OID	Name	Access	Description	Syntax
x.3.2.1.1.0	deviceID	read-only	Device ID (default MAC address)	MacAddress
x.3.2.1.2.0	hostName	read-only	Hostname	DisplayString
x.3.2.1.3.0	deviceIP	read-only	Device IP address	IpAddress

setup -> io -> sensorsSetup -> sensor1setup

OID	Name	Access	Description	Syntax
x.3.2.2.1.1.1.0	s1description	read-write	Sensor 1 description	DisplayString
x.3.2.2.1.1.2.1.0	s11MAXInt	read-write	S11 maximum value x1000 in Integer format	Integer32
x.3.2.2.1.1.2.2.0	s11MINInt	read-write	S11 minimum value x1000 in Integer format	Integer32
x.3.2.2.1.1.2.3.0	s11HYSTInt	read-write	S11 hysteresis value x1000 in Integer format	Integer32
x.3.2.2.1.1.3.1.0	s12MAXInt	read-write	S12 maximum value x1000 in Integer format	Integer32
x.3.2.2.1.1.3.2.0	s12MINInt	read-write	S12 minimum value x1000 in Integer format	Integer32
x.3.2.2.1.1.3.3.0	s12HYSTInt	read-write	S12 hysteresis value x1000 in Integer format	Integer32

setup -> io -> sensorsSetup -> sensor2setup

OID	Name	Access	Description	Syntax
x.3.2.2.1.2.1.0	s2description	read-write	Sensor2 description	DisplayString
x.3.2.2.1.2.2.1.0	s21MAXInt	read-write	s21 maximum value x1000 in Integer format	Integer32
x.3.2.2.1.2.2.2.0	S21MINInt	read-write	S21 minimum value x1000 in Integer format	Integer32
x.3.2.2.1.2.2.3.0	S21HYSTInt	read-write	S21 hysteresis value x1000 in Integer format	Integer32
x.3.2.2.1.2.3.1.0	S22MAXInt	read-write	S22 maximum value x1000 in Integer format	Integer32
x.3.2.2.1.2.3.2.0	S22MINInt	read-write	S22 minimum value x1000 in Integer format	Integer32
x.3.2.2.1.2.3.3.0	S22HYSTInt	read-write	S22 hysteresis value x1000 in Integer format	Integer32

setup -> io -> sensorsSetup -> sensor3setup

OID	Name	Access	Description	Syntax
x.3.2.2.1.3.1.0	S3description	read-write	Sensor 3 description	DisplayString
x.3.2.2.1.3.2.1.0	S31MAXInt	read-write	S31 maximum value x1000 in Integer format	Integer32
x.3.2.2.1.3.2.2.0	S31MINInt	read-write	S31 minimum value x1000 in Integer format	Integer32
x.3.2.2.1.3.2.3.0	S31HYSTInt	read-write	S31 hysteresis value x1000 in Integer format	Integer32
x.3.2.2.1.3.3.1.0	S32MAXInt	read-write	S32 maximum value x1000 in Integer format	Integer32
x.3.2.2.1.3.3.2.0	S32MINInt	read-write	S32 minimum value x1000 in Integer format	Integer32
x.3.2.2.1.3.3.3.0	S32HYSTInt	read-write	S32 hysteresis value x1000 in Integer format	Integer32

setup -> io -> sensorsSetup -> sensor4setup

OID	Name	Access	Description	Syntax
x.3.2.2.1.4.1.0	S4description	read-write	Sensor 4 description	DisplayString
x.3.2.2.1.4.2.1.0	S41MAXInt	read-write	S41 maximum value x1000 in Integer format	Integer32
x.3.2.2.1.4.2.2.0	S41MINInt	read-write	S41 minimum value x1000 in Integer format	Integer32
x.3.2.2.1.4.2.3.0	S41HYSTInt	read-write	S41 hysteresis value x1000 in Integer format	Integer32
x.3.2.2.1.4.3.1.0	S42MAXInt	read-write	S42 maximum value x1000 in Integer format	Integer32
x.3.2.2.1.4.3.2.0	S42MINInt	read-write	S42 minimum value x1000 in Integer format	Integer32
x.3.2.2.1.4.3.3.0	S42HYSTInt	read-write	S42 hysteresis value x1000 in Integer format	Integer32

setup -> io -> sensorsSetup -> sensor5setup

OID	Name	Access	Description	Syntax
x.3.2.2.1.5.1.0	S5description	read-write	Sensor 5 description	DisplayString
x.3.2.2.1.5.2.1.0	S51MAXInt	read-write	S51 maximum value x1000 in Integer format	Integer32
x.3.2.2.1.5.2.2.0	S51MINInt	read-write	S51 minimum value x1000 in Integer format	Integer32
x.3.2.2.1.5.2.3.0	S51HYSTInt	read-write	S51 hysteresis value x1000 in Integer format	Integer32
x.3.2.2.1.5.3.1.0	S52MAXInt	read-write	S52 maximum value x1000 in Integer format	Integer32
x.3.2.2.1.5.3.2.0	S52MINInt	read-write	S52 minimum value x1000 in Integer format	Integer32
x.3.2.2.1.5.3.3.0	S52HYSTInt	read-write	S52 hysteresis value x1000 in Integer format	Integer32

setup -> io -> sensorsSetup -> sensor6setup

OID	Name	Access	Description	Syntax
x.3.2.2.1.6.1.0	S6description	read-write	Sensor 6 description	DisplayString
x.3.2.2.1.6.2.1.0	S61MAXInt	read-write	S61 maximum value x1000 in Integer format	Integer32
x.3.2.2.1.6.2.2.0	S61MINInt	read-write	S61 minimum value x1000 in Integer format	Integer32
x.3.2.2.1.6.2.3.0	S61HYSTInt	read-write	S61 hysteresis value x1000 in Integer format	Integer32
x.3.2.2.1.6.3.1.0	S62MAXInt	read-write	S62 maximum value x1000 in Integer format	Integer32
x.3.2.2.1.6.3.2.0	S62MINInt	read-write	S62 minimum value x1000 in Integer format	Integer32
x.3.2.2.1.6.3.3.0	S62HYSTInt	read-write	S62 hysteresis value x1000 in Integer format	Integer32

setup -> io -> sensorsSetup -> sensor7setup

OID	Name	Access	Description	Syntax
x.3.2.2.1.7.1.0	S7description	read-write	Sensor 7 description	DisplayString
x.3.2.2.1.7.2.1.0	S71MAXInt	read-write	S71 maximum value x1000 in Integer format	Integer32
x.3.2.2.1.7.2.2.0	S71MINInt	read-write	S71 minimum value x1000 in Integer format	Integer32
x.3.2.2.1.7.2.3.0	S71HYSTInt	read-write	S71 hysteresis value x1000 in Integer format	Integer32
x.3.2.2.1.7.3.1.0	S72MAXInt	read-write	S72 maximum value x1000 in Integer format	Integer32
x.3.2.2.1.7.3.2.0	S72MINInt	read-write	S72 minimum value x1000 in Integer format	Integer32
x.3.2.2.1.7.3.3.0	S72HYSTInt	read-write	S72 hysteresis value x1000 in Integer format	Integer32

setup -> io -> sensorsSetup -> sensor8setup

OID	Name	Access	Description	Syntax
x.3.2.2.1.8.1.0	S8description	read-write	Sensor 8 description	DisplayString
x.3.2.2.1.8.2.1.0	S81MAXx10Int	read-write	S81 maximum value x1000 in Integer format	Integer32
x.3.2.2.1.8.2.2.0	S81MINx10Int	read-write	S81 minimum value x1000 in Integer format	Integer32
x.3.2.2.1.8.2.3.0	S81HYSTx10Int	read-write	S81 hysteresis value x1000 in Integer format	Integer32
x.3.2.2.1.8.3.1.0	S82MAXx10Int	read-write	S82 maximum value x1000 in Integer format	Integer32
x.3.2.2.1.8.3.2.0	S82MINx10Int	read-write	S82 minimum value x1000 in Integer format	Integer32
x.3.2.2.1.8.3.3.0	S82HYSTx10Int	read-write	S82 hysteresis value x1000 in Integer format	Integer32

setup -> io -> analogSetup -> analog1setup

OID	Name	Access	Description	Syntax
x.3.2.2.2.1.1.0	voltage1description	read-write	Voltage 1 description	DisplayString
x.3.2.2.2.1.2.0	voltage1max	read-write	Voltage 1 maximum	Integer32
x.3.2.2.2.1.3.0	voltage1min	read-write	Voltage 1 minimum	Integer32
x.3.2.2.2.1.4.0	voltage1hyst	read-write	Voltage 1 hysteresis	Integer32

setup -> io -> analogSetup -> analog2setup

OID	Name	Access	Description	Syntax
x.3.2.2.2.2.1.0	voltage2description	read-write	Voltage 2 description	DisplayString
x.3.2.2.2.2.2.0	voltage2max	read-write	Voltage 2 maximum	Integer32
x.3.2.2.2.2.3.0	voltage2min	read-write	Voltage 2 minimum	Integer32
x.3.2.2.2.2.4.0	voltage2hyst	read-write	Voltage 2 hysteresis	Integer32

setup -> io -> analogSetup -> analog3setup

OID	Name	Access	Description	Syntax
x.3.2.2.2.3.1.0	voltage3description	read-write	Voltage 3 description	DisplayString
x.3.2.2.2.3.2.0	voltage3max	read-write	Voltage 3 maximum	Integer32
x.3.2.2.2.3.3.0	voltage3min	read-write	Voltage 3 minimum	Integer32
x.3.2.2.2.3.4.0	voltage3hyst	read-write	Voltage 3 hysteresis	Integer32

setup -> io -> analogSetup -> analog4setup

OID	Name	Access	Description	Syntax
x.3.2.2.2.4.1.0	voltage4description	read-write	Voltage 4 description	DisplayString
x.3.2.2.2.4.2.0	voltage4max	read-write	Voltage 4 maximum	Integer32
x.3.2.2.2.4.3.0	voltage4min	read-write	Voltage 4 minimum	Integer32
x.3.2.2.2.4.4.0	voltage4hyst	read-write	Voltage 4 hysteresis	Integer32

setup -> io -> digitalSetup

OID	Name	Access	Description	Syntax
x.3.2.2.3.1.0	digitalInput1description	read-write	Digital Input 1 description"	DisplayString
x.3.2.2.3.2.0	digitalInput2description	read-write	Digital Input 2 description	DisplayString
x.3.2.2.3.3.0	digitalInput3description	read-write	Digital Input 3 description	DisplayString
x.3.2.2.3.4.0	digitalInput3description	read-write	Digital Input 4 description	DisplayString

setup -> io -> relaysSetup -> relay1setup

OID	Name	Access	Description	Syntax
x.3.2.2.4.1.1.0	relay1description	read-write	Relay 1 description	DisplayString
x.3.2.2.4.1.2.0	relay1pulseWidth	read-write	Relay1 Pulse x100ms	Integer32
x.3.2.2.4.1.3.0	relay1controlledBy	read-write	Relay1 control logic	Integer32 { manual(0),sensor11(1), sensor21(2),sensor31(3),sensor41(4),sensor51(5),sensor61(6),sensor71(7),sensor81(8),sensor12(9),sensor22(10),sensor32(11),sensor42(12),sensor52(13),sensor62(14),sensor72(15),sensor82(16),analog1(17),analog2(18),analog3(19),analog4(20),digital1(21),digital2(22),digital3(23),digital4(24),anyAlarm(25),anySensor(26),anyAnalog(27),anyDigital(28),func1(29), func2(30),shedule1(31),shedule2(32),shedule3(33),shedule4(34) }

setup -> io-> relaysSetup -> relay2setup

OID	Name	Access	Description	Syntax
x.3.2.2.4.2.1.0	relay2description	read-write	Relay 2 description	DisplayString
x.3.2.2.4.2.2.0	relay2pulseWidth	read-write	Relay 2 Pulse x100ms	Integer32
x.3.2.2.4.2.3.0	relay2controlledBy	read-write	Relay 2 control logic	Integer32 { manual(0),sensor11(1), sensor21(2),sensor31(3),sensor41(4),sensor51(5),sensor61(6),sensor71(7),sensor81(8),sensor12(9),sensor22(10),sensor32(11),sensor42(12),sensor52(13),sensor62(14),sensor72(15),sensor82(16),analog1(17),analog2(18),analog3(19),analog4(20),digital1(21),digital2(22),digital3(23),digital4(24),anyAlarm(25),anySensor(26),anyAnalog(27),anyDigital(28),func1(29), func2(30),shedule1(31),shedule2(32),shedule3(33),shedule4(34) }

setup -> io-> relaysSetup -> relay3setup

OID	Name	Access	Description	Syntax
x.3.2.2.4.3.1.0	relay3description	read-write	Relay 3 description	DisplayString
x.3.2.2.4.3.2.0	relay3pulseWidth	read-write	Relay 3 Pulse x100ms	Integer32
x.3.2.2.4.3.3.0	relay3controlledBy	read-write	Relay 3 control logic	Integer32 { manual(0),sensor11(1), sensor21(2),sensor31(3),sensor41(4),sensor51(5),sensor61(6),sensor71(7),sensor81(8),sensor12(9),sensor22(10),sensor32(11),sensor42(12),sensor52(13),sensor62(14),sensor72(15),sensor82(16),analog1(17),analog2(18),analog3(19),analog4(20),digital1(21),digital2(22),digital3(23),digital4(24),anyAlarm(25),anySensor(26),anyAnalog(27),anyDigital(28),func1(29), func2(30),shedule1(31),shedule2(32),shedule3(33),shedule4(34) }

setup -> io-> relaysSetup -> relay4setup

OID	Name	Access	Description	Syntax
x.3.2.2.4.4.1.0	relay4description	read-write	Relay 4 description	DisplayString
x.3.2.2.4.4.2.0	relay4pulseWidth	read-write	Relay 4 Pulse x100ms	Integer32
x.3.2.2.4.4.3.0	relay4controlledBy	read-write	Relay 4 control logic	Integer32 { manual(0),sensor11(1), sensor21(2),sensor31(3),sensor41(4),sensor51(5),sensor61(6),sensor71(7),sensor81(8),sensor12(9),sensor22(10),sensor32(11),sensor42(12),sensor52(13),sensor62(14),sensor72(15),sensor82(16),analog1(17),analog2(18),analog3(19),analog4(20),digital1(21),digital2(22),digital3(23),digital4(24),anyAlarm(25),anySensor(26),anyAnalog(27),anyDigital(28),func1(29), func2(30),shedule1(31),shedule2(32),shedule3(33),shedule4(34) }

monitorNcontrol -> sensors -> sensor1

OID	Name	Access	Description	Syntax
x.3.3.1.1.1.0	s11Int	read-only	S11 value x1000 in Integer format	Integer32
x.3.3.1.1.2.0	s12Int	read-only	S12 value x1000 in Integer format	Integer32
x.3.3.1.1.3.0	s1ID	read-only	S1 ID value	Mac Address

monitorNcontrol -> sensors -> sensor2

OID	Name	Access	Description	Syntax
x.3.3.1.2.1.0	s21Int	read-only	S21 value x1000 in Integer format	Integer32
x.3.3.1.2.2.0	s22Int	read-only	S22 value x1000 in Integer format	Integer32
x.3.3.1.2.3.0	s2ID	read-only	S2 ID value	OCTET STRING (SIZE (16))

monitorNcontrol -> sensors -> sensor3

OID	Name	Access	Description	Syntax
x.3.3.1.3.1.0	s31Int	read-only	S31 value x1000 in Integer format	Integer32
x.3.3.1.3.2.0	s32Int	read-only	S32 value x1000 in Integer format	Integer32
x.3.3.1.3.3.0	s3ID	read-only	S3 ID value	OCTET STRING (SIZE (16))

monitorNcontrol -> sensors -> sensor4

OID	Name	Access	Description	Syntax
x.3.3.1.4.1.0	s41Int	read-only	S41 value x1000 in Integer format	Integer32
x.3.3.1.4.2.0	s42Int	read-only	S42 value x1000 in Integer format	Integer32
x.3.3.1.4.3.0	s4ID	read-only	S4 ID value	OCTET STRING (SIZE (16))

monitorNcontrol -> sensors -> sensor5

OID	Name	Access	Description	Syntax
x.3.3.1.5.1.0	s51Int	read-only	S51 value x1000 in Integer format	Integer32
x.3.3.1.5.2.0	s52Int	read-only	S52 value x1000 in Integer format	Integer32
x.3.3.1.5.3.0	s5ID	read-only	S5 ID value	OCTET STRING (SIZE (16))

monitorNcontrol -> sensors -> sensor6

OID	Name	Access	Description	Syntax
x.3.3.1.6.1.0	s61Int	read-only	S61 value x1000 in Integer format	Integer32
x.3.3.1.6.2.0	s62Int	read-only	S62 value x1000 in Integer format	Integer32
x.3.3.1.6.3.0	s6ID	read-only	S6 ID value	OCTET STRING (SIZE (16))

monitorNcontrol -> sensors -> sensor7

OID	Name	Access	Description	Syntax
x.3.3.1.7.1.0	s71Int	read-only	S71 value x1000 in Integer format	Integer32
x.3.3.1.7.2.0	s72Int	read-only	S72 value x1000 in Integer format	Integer32
x.3.3.1.7.3.0	s7ID	read-only	S7 ID value	OCTET STRING (SIZE (16))

monitorNcontrol -> sensors -> sensor8

OID	Name	Access	Description	Syntax
x.3.3.1.8.1.0	s81Int	read-only	S81 value x1000 in Integer format	Integer32
x.3.3.1.8.2.0	s82Int	read-only	S82 value x1000 in Integer format	Integer32
x.3.3.1.8.3.0	s8ID	read-only	S8 ID value	OCTET STRING (SIZE (16))

monitorNcontrol -> analog

OID	Name	Access	Description	Syntax
x.3.3.2.1.0	voltage1Int	read-only	Voltage1 x1000 in Integer format	Integer32
x.3.3.2.2.0	voltage2Int	read-only	Voltage2 x1000 in Integer format	Integer32
x.3.3.2.3.0	voltage3Int	read-only	Voltage3 x1000 in Integer format	Integer32
x.3.3.2.4.0	voltage4Int	read-only	Voltage4 x1000 in Integer format	Integer32

monitorNcontrol -> digital

OID	Name	Access	Description	Syntax
x.3.3.3.1.0	digitalInput1State	read-only	Digital1 Input State	INTEGER {closed(0), open(1)}
x.3.3.3.2.0	digitalInput2State	read-only	Digital2 Input State	INTEGER {closed(0), open(1)}
x.3.3.3.3.0	digitalInput3State	read-only	Digital3 Input State	INTEGER {closed(0), open(1)}
x.3.3.3.4.0	digitalInput4State	read-only	Digital4 Input State	INTEGER {closed(0), open(1)}

monitorNcontrol -> relays -> relay1

OID	Name	Access	Description	Syntax
x.3.3.4.1.1.0	relay1State	read-write	Relay1 State	INTEGER {off(0), on(1)}
x.3.3.4.1.2.0	relay1Pulse	read-write	Relay1 Pulse	INTEGER {off(0), on(1)}

monitorNcontrol -> relays -> relay2

OID	Name	Access	Description	Syntax
x.3.3.4.2.1.0	relay2State	read-write	Relay2 State	INTEGER {off(0), on(1)}
x.3.3.4.2.2.0	relay2pulse	read-write	Relay2 pulse length	INTEGER {off(0), on(1)}

monitorNcontrol -> relays -> relay3

OID	Name	Access	Description	Syntax
x.3.3.4.3.1.0	relay3State	read-write	Relay3 State	INTEGER {off(0), on(1)}
x.3.3.4.3.2.0	relay3pulse	read-write	Relay3 pulse length	INTEGER {off(0), on(1)}

monitorNcontrol -> relays -> relay4

OID	Name	Access	Description	Syntax
x.3.3.4.4.1.0	relay4State	read-write	Relay4 State	INTEGER {off(0), on(1)}
x.3.3.4.4.2.0	relay4pulse	read-write	Relay4 pulse length	INTEGER {off(0), on(1)}

monitorNcontrol

OID	Name	Access	Description	Syntax
x.3.3.5.0	configurationSaved	read-write	Configuration save status SAVED/UNSAVED	INTEGER { unsaved(0), saved(1) }
x.3.3.6.0	restartDevice	read-write	Restart Device	INTEGER { cancel(0), restart(1) }
x.3.3.7.0	temperatureUnit	read-only	Unit of the all temperature values	INTEGER { celcius(0), fahrenheit(1) }
x.3.3.8.0	hardwareErr	read-only	Hardware Error	INTEGER { noErr(0), owErr(1), hwErr(2) }

8.2. HTTP API

8.2.1. HTTP Post

TCW241 can execute HTTP Post to upload XML/JSON file to dedicated server.

This functionality is very useful if the controller is behind the router without public IP address or the user don't have access to router configuration. The server should have public IP address.

Typical monitoring application is shown on the picture below:

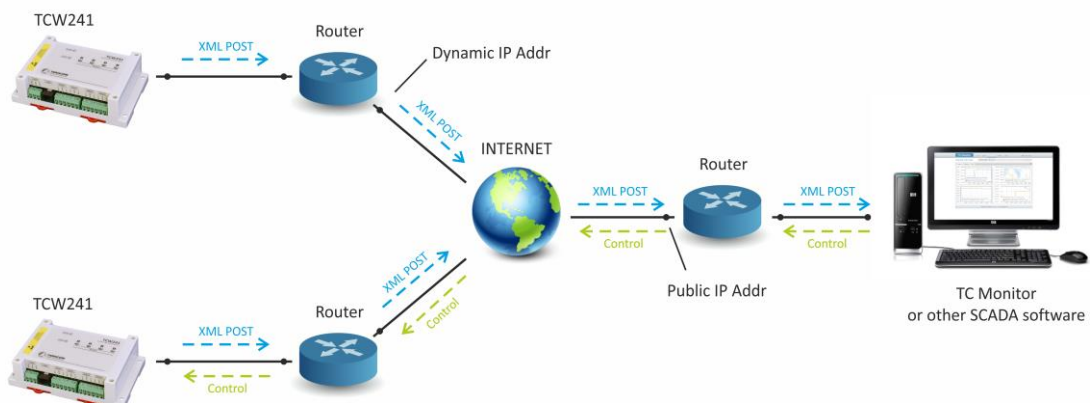

HTTP post can be send periodically or periodically plus on alarm condition. As an answer, server can send HTTP Get with appropriate command – see **8.2.3. HTTP commands**

To test HTTP Post follow the steps below:

- Save following code like post.php:

```
<?php
define("FILENAME", 'status.xml');
define("FOLDER", "");
define("SEPARATOR", "");
define("STR_SUCCESS", 'set FIN');
define("STR_ERROR", 'error');

if($_SERVER['REQUEST_METHOD'] == 'POST'){
    $datePrefix = date('YmdHis', strtotime('now'));
    $pathname = FOLDER.SEPARATOR.$datePrefix.'_' . FILENAME;
    $postdata = file_get_contents("php://input");
    $handle = fopen($pathname, 'w+');
    $content = var_export($postdata, true);
    fwrite($handle, substr($content, 1, strlen($content)-2));
    fclose($handle);
    echo (($handle === false) ? STR_ERROR : STR_SUCCESS)."\r\n";
}
else {
    echo "The PHP script is working!";
}
?>
```

- Copy the post.php file on public web server with PHP support. To verify that the script is working properly, you can type the URL (for example: www.yourserverURL.com/post.php) in your web browser. If all is OK, a webpage with “The PHP script is working!” will be shown.
- Set the controller to send HTTP POST to your webserver. Enter the address (yourserverURL.com/post.php) in the URL field. Click on “Test HTTP Post” button.
- If the HTTP POST is received and processed, “OK” will be shown close to the button. Along with this a XML file will be created in the same directory, where post.php is located. The file name will contain time information and looks as 20151120103318_status.xml.

8.2.2. HTTP Get

HTTP Get can be used to monitor **TCW241** via XML or JSON files. The format is as follows:

<http://device.ip.address/status.xml>

<http://device.ip.address/status.json>

See sections **8.2.4 XML file structure** and **8.2.5 JSON file structure** for details of files.

The device supports basic access authentication. This should be count if HTTP API authentication is enabled.

HTTP Get can be sent in any time to **TCW241** if it is in same network or it has appropriate routing. If there isn't direct access to device, HTTP Get can be sent immediately after HTTP Post receiving from same device.

8.2.3. HTTP commands

TCW241 supports following commands for relay activation, sent as HTTP GET:

Command	Description
http://device.ip.address/system/config.xml?ron=1	Turn Relay 1 ON
http://device.ip.address/system/config.xml?rof=1	Turn Relay 1 OFF
http://device.ip.address/system/config.xml?ron=2	Turn Relay 2 ON
http://device.ip.address/system/config.xml?rof=2	Turn Relay 2 OFF
http://device.ip.address/system/config.xml?ron=4	Turn Relay 3 ON
http://device.ip.address/system/config.xml?rof=4	Turn Relay 3 OFF
http://device.ip.address/system/config.xml?ron=8	Turn Relay 4 ON
http://device.ip.address/system/config.xml?rof=8	Turn Relay 4 OFF
http://device.ip.address/system/config.xml?rtg=1	Toggle Relay 1 state
http://device.ip.address/system/config.xml?rtg=2	Toggle Relay 2 state

http://device.ip.address/system/config.xml?rtg=4	Toggle Relay 3 state
http://device.ip.address/system/config.xml?rtg=8	Toggle Relay 4 state
http://device.ip.address/system/config.xml?rpl=1	Pulse Relay 1
http://device.ip.address/system/config.xml?rpl=2	Pulse Relay 2
http://device.ip.address/system/config.xml?rpl=4	Pulse Relay 3
http://device.ip.address/system/config.xml?rpl=8	Pulse Relay 4
http://device.ip.address/system/config.xml?ron=1&ron=2&ron=4&ron=8	Turn four relays ON
http://device.ip.address/system/config.xml?rof=1&rof=2&rof=4&rof=8	Turn four relays OFF

The device supports basic access authentication. This should be count if HTTP API authentication is enabled.

8.2.4. XML file structure

```

<Monitor>
  <DeviceInfo>
    <DeviceName>TCW241</DeviceName>
    <HostName>TCW241</HostName>
    <ID>D8-80-39-35-55-22</ID>
    <FwVer>tcw-v1.000</FwVer>
    <MnflInfo>www.teracom.cc</MnflInfo>
  </DeviceInfo>
  <S>
    <S1>
      <description>S1:TST100/1/2/3</description>
      <id>28C4C109030000C5</id>
      <item1>
        <value>12.7</value>
        <unit>°C</unit>
        <alarm>0</alarm>
      </item1>
      <item2>
        <value>---</value>
        <unit>---</unit>
        <alarm>0</alarm>
      </item2>
    </S1>
    <S2>
      <description>S2:TST100/1/2/3</description>
      <id>2819D009030000FA</id>
      <item1>
        <value>12.8</value>
        <unit>°C</unit>
        <alarm>0</alarm>
      </item1>
      <item2>
        <value>---</value>
        <unit>---</unit>
        <alarm>0</alarm>
      </item2>
    </S2>
    <S3>
      <description>S3:TST100/1/2/3</description>
      <id>2867895F07000058</id>
      <item1>
        <value>13.0</value>
        <unit>°C</unit>
        <alarm>0</alarm>
      </item1>
      <item2>
        <value>---</value>
        <unit>---</unit>
        <alarm>0</alarm>
      </item2>
    </S3>
    <S4>
      <description>S4:TSH201/2/3</description>
      <id>01D01FB71700FFF8</id>
      <item1>

```

```

        <value>12.9</value>
        <unit>°C</unit>
        <alarm>0</alarm>
    </item1>
    <item2>
        <value>57.2</value>
        <unit>%RH</unit>
        <alarm>0</alarm>
    </item2>
</S4>
<S5>
    <description>S5</description>
    <id>0000000000000000</id>
    <item1>
        <value>---</value>
        <unit>---</unit>
        <alarm>0</alarm>
    </item1>
    <item2>
        <value>---</value>
        <unit>---</unit>
        <alarm>0</alarm>
    </item2>
</S5>
<S6>
    <description>S6</description>
    <id>0000000000000000</id>
    <item1>
        <value>---</value>
        <unit>---</unit>
        <alarm>0</alarm>
    </item1>
    <item2>
        <value>---</value>
        <unit>---</unit>
        <alarm>0</alarm>
    </item2>
</S6>
<S7>
    <description>S7</description>
    <id>0000000000000000</id>
    <item1>
        <value>---</value>
        <unit>---</unit>
        <alarm>0</alarm>
    </item1>
    <item2>
        <value>---</value>
        <unit>---</unit>
        <alarm>0</alarm>
    </item2>
</S7>
<S8>
    <description>S8</description>
    <id>0000000000000000</id>
    <item1>
        <value>---</value>
        <unit>---</unit>
        <alarm>0</alarm>
    </item1>
    <item2>
        <value>---</value>
        <unit>---</unit>
        <alarm>0</alarm>
    </item2>
</S8>
</S>
<AI>
    <AI1>
        <description>Analog Input 1</description>
        <value>10.49</value>
        <unit>V</unit>
        <multiplier>1.000</multiplier>
        <offset>0.000</offset>
        <alarm>1</alarm>
    </AI1>
    <AI2>
        <description>Analog Input 2</description>

```

```

        <value>10.50</value>
        <unit>V</unit>
        <multiplier>1.000</multiplier>
        <offset>0.000</offset>
        <alarm>1</alarm>
    </AI2>
    <AI3>
        <description>Analog Input 3</description>
        <value>5.09</value>
        <unit>V</unit>
        <multiplier>1.000</multiplier>
        <offset>0.000</offset>
        <alarm>1</alarm>
    </AI3>
    <AI4>
        <description>Analog Input 4</description>
        <value>5.10</value>
        <unit>V</unit>
        <multiplier>1.000</multiplier>
        <offset>0.000</offset>
        <alarm>1</alarm>
    </AI4>
</AI>
<DI>
    <DI1>
        <description>Digital Input 1</description>
        <value>OPEN</value>
        <valuebin>1</valuebin>
        <alarmState>CLOSED</alarmState>
        <alarm>0</alarm>
    </DI1>
    <DI2>
        <description>Digital Input 2</description>
        <value>OPEN</value>
        <valuebin>1</valuebin>
        <alarmState>CLOSED</alarmState>
        <alarm>0</alarm>
    </DI2>
    <DI3>
        <description>Digital Input 3</description>
        <value>OPEN</value>
        <valuebin>1</valuebin>
        <alarmState>CLOSED</alarmState>
        <alarm>0</alarm>
    </DI3>
    <DI4>
        <description>Digital Input 4</description>
        <value>OPEN</value>
        <valuebin>1</valuebin>
        <alarmState>CLOSED</alarmState>
        <alarm>0</alarm>
    </DI4>
</DI>
<R>
    <R1>
        <description>Relay 1</description>
        <value>OFF</value>
        <valuebin>0</valuebin>
        <pulseWidth>1</pulseWidth>
        <control>0</control>
    </R1>
    <R2>
        <description>Relay 2</description>
        <value>OFF</value>
        <valuebin>0</valuebin>
        <pulseWidth>1</pulseWidth>
        <control>0</control>
    </R2>
    <R3>
        <description>Relay 3</description>
        <value>OFF</value>
        <valuebin>0</valuebin>
        <pulseWidth>1</pulseWidth>
        <control>0</control>
    </R3>
    <R4>
        <description>Relay 4</description>
        <value>OFF</value>

```

```

        <valuebin>0</valuebin>
        <pulseWidth>1</pulseWidth>
        <control>0</control>
    </R4>
</R>
<HTTPPush>
    <Key/>
    <PushPeriod>300</PushPeriod>
</HTTPPush>
<hwerr/>
<Alarmed>1</Alarmed>
<Time>
    <Date>11.01.2016</Date>
    <Time>08:07:23</Time>
</Time>
</Monitor>

```

Where:

<value>--- </value> and <unit>--- </unit> means no 1-Wire sensor on this position;
 <alarm>1</alarm> means there is trigger condition.

8.2.5. JSON file structure

```

{
  "Monitor": {
    "DeviceInfo": {
      "DeviceName": "TCW241",
      "HostName": "TCW241",
      "ID": "D8-80-39-35-55-22",
      "FwVer": "tcw-v1.000",
      "MnflInfo": "www.teracom.cc"
    },
    "S": {
      "S1": {
        "description": "S1:TST100/1/2/3",
        "id": "28C4C109030000C5",
        "item1": {
          "value": "14.9",
          "unit": "B°C",
          "alarm": "0"
        },
        "item2": {
          "value": "---",
          "unit": "---",
          "alarm": "0"
        }
      },
      "S2": {
        "description": "S2:TST100/1/2/3",
        "id": "2819D009030000FA",
        "item1": {
          "value": "15.1",
          "unit": "B°C",
          "alarm": "0"
        },
        "item2": {
          "value": "---",
          "unit": "---",
          "alarm": "0"
        }
      },
      "S3": {
        "description": "S3:TST100/1/2/3",
        "id": "2867895F07000058",
        "item1": {
          "value": "15.0",
          "unit": "B°C",
          "alarm": "0"
        },
        "item2": {
          "value": "---",
          "unit": "---",
          "alarm": "0"
        }
      }
    }
  }
}

```

```

},
"S4": {
  "description": "S4:TSH201/2/3",
  "id": "01D01FB71700FFF8",
  "item1": {
    "value": "15.9",
    "unit": "B°C",
    "alarm": "0"
  },
  "item2": {
    "value": "58.8",
    "unit": "%RH",
    "alarm": "0"
  }
},
"S5": {
  "description": "S5",
  "id": "0000000000000000",
  "item1": {
    "value": "---",
    "unit": "---",
    "alarm": "0"
  },
  "item2": {
    "value": "---",
    "unit": "---",
    "alarm": "0"
  }
},
"S6": {
  "description": "S6",
  "id": "0000000000000000",
  "item1": {
    "value": "---",
    "unit": "---",
    "alarm": "0"
  },
  "item2": {
    "value": "---",
    "unit": "---",
    "alarm": "0"
  }
},
"S7": {
  "description": "S7",
  "id": "0000000000000000",
  "item1": {
    "value": "---",
    "unit": "---",
    "alarm": "0"
  },
  "item2": {
    "value": "---",
    "unit": "---",
    "alarm": "0"
  }
},
"S8": {
  "description": "S8",
  "id": "0000000000000000",
  "item1": {
    "value": "---",
    "unit": "---",
    "alarm": "0"
  },
  "item2": {
    "value": "---",
    "unit": "---",
    "alarm": "0"
  }
},
"AI": {
  "AI1": {
    "description": "Analog Input 1",
    "value": "10.49",
    "unit": "V",
    "multiplier": "1.000",

```

```

        "offset": "0.000",
        "alarm": "1"
    },
    "AI2": {
        "description": "Analog Input 2",
        "value": "10.50",
        "unit": "V",
        "multiplier": "1.000",
        "offset": "0.000",
        "alarm": "1"
    }
}
"AI3": {
    "description": "Analog Input 3",
    "value": "5.09",
    "unit": "V",
    "multiplier": "1.000",
    "offset": "0.000",
    "alarm": "1"
}
"AI4": {
    "description": "Analog Input 4",
    "value": "5.10",
    "unit": "V",
    "multiplier": "1.000",
    "offset": "0.000",
    "alarm": "1"
}
},
"DI": {
    "DI1": {
        "description": "Digital Input 1",
        "value": "OPEN",
        "valuebin": "1",
        "alarmState": "CLOSED",
        "alarm": "0"
    },
    "DI2": {
        "description": "Digital Input 2",
        "value": "OPEN",
        "valuebin": "1",
        "alarmState": "CLOSED",
        "alarm": "0"
    }
}
"DI3": {
    "description": "Digital Input 3",
    "value": "OPEN",
    "valuebin": "1",
    "alarmState": "CLOSED",
    "alarm": "0"
}
"DI3": {
    "description": "Digital Input 4",
    "value": "OPEN",
    "valuebin": "1",
    "alarmState": "CLOSED",
    "alarm": "0"
}
},
"R": {
    "R1": {
        "description": "Relay 1",
        "value": "OFF",
        "valuebin": "0",
        "pulseWidth": "1",
        "control": "0"
    },
    "R2": {
        "description": "Relay 2",
        "value": "OFF",
        "valuebin": "0",
        "pulseWidth": "1",
        "control": "0"
    }
}
"R3": {
    "description": "Relay 3",
    "value": "OFF",
    "valuebin": "0",
    "pulseWidth": "1",

```

```

        "control": "0"
    }
    "R4": {
        "description": "Relay 4",
        "value": "OFF",
        "valuebin": "0",
        "pulseWidth": "1",
        "control": "0"
    }
},
"HTTPPush": {
    "Key": "",
    "PushPeriod": "300"
},
"hwerr": "",
"Alarmed": "1",
"Time": {
    "Date": "11.01.2016",
    "Time": "08:56:00"
}
}
}

```

8.3. MODBUS

Modbus protocol is a serial communications protocol originally published by Modicon in 1979. It is used to establish master-slave/client-server communication between intelligent devices. Modbus is often used to connect a supervisory computer with remote terminal unit (RTU) in supervisory control and data acquisition (SCADA) systems.

8.3.1. Codes and answers

8.3.1.1. Read Coil Status (FC=01)

Request

This command is requesting the ON/OFF status of discrete coils on address 100.

01 0064 0001

01: The Function Code 1 (read Coil Status)

0064: The Data Address of the coil to read (0064 hex = 100)

0001: The total number of coils requested. (01 hex = 1)

Response

01 01 01

01: The Function Code 1 (read Coil Status)

01: The number of data bytes to follow

01: 7 space holders & Coils 1 (0000 0001)

Due to the number of coils requested, the last data field **01** contains the status of only 1 coil. The 7 most significant bits in this data field are filled in with zeroes.

Activated relay is 1.

8.3.1.2. Force Single Coil (FC=05)

Request

This command is writing the contents of discrete on address 100 to ON.

05 0064 FF00

05: The Function Code 5 (Force Single Coil)

0064: The Data Address of the coil. (0064 hex = 100)

FF00: The status to write (FF00 = ON, 0000 = OFF)

Response

The normal response is an echo of the query, returned after the coil has been written.

05 0064 FF00

03: The Function Code 3 (read Analog Output Holding Registers)
 40: The number of data bytes to follow (32 registers x 2 bytes each = 64 bytes)
 5365 6e73 6f72 3100 0000 0000 0000 0000 0000 0000 0000 0000 0000
 0000 0000 0000 0000 0000 0000 0000 0000 0000 0000 0000 0000
 0000 0000 0000 0000 0000 0000 0000 0000: 64 bytes value
 All holding registers with strings are sent in big-endian.
 The answer is padded with 0.
 In the example above string "Sensor1" is sent.

8.3.1.5. Exception codes

All exceptions are signaled by adding 0x80 to the function code of the request, and following this byte by a single reason byte for example as follows:

01 Illegal function

The function code received in the query is not an allowable action for the controller.

02 Illegal data address

The data address received in the query is not an allowable address for the slave. More specifically, the combination of reference number and transfer length is invalid. For a controller with 100 registers, a request with offset 96 and length 4 would succeed, a request with offset 96 and length 5 will generate exception 02.

8.3.2. Address table

Parameter	FC	Address (Decimal)	Data size
Read Relay 1	01	100	Discrete
Read Relay 2	01	101	Discrete
Read Relay 3	01	102	Discrete
Read Relay 4	01	103	Discrete

Write Relay 1	05	100	Discrete
Write Relay 2	05	101	Discrete
Write Relay 3	05	102	Discrete
Write Relay 4	05	103	Discrete

Read Digital Input 1	02	100	Discrete
Read Digital Input 2	02	101	Discrete
Read Digital Input 3	02	102	Discrete
Read Digital Input 4	02	103	Discrete

Number of installed sensors	03	99	16-bit Integer
Read Sensor 11	03	100	32-bit Float
Read Sensor 12	03	102	32-bit Float
Read Sensor 21	03	104	32-bit Float
Read Sensor 22	03	106	32-bit Float
Read Sensor 31	03	108	32-bit Float
Read Sensor 32	03	110	32-bit Float

Read Sensor 41	03	112	32-bit Float
Read Sensor 42	03	114	32-bit Float
Read Sensor 51	03	116	32-bit Float
Read Sensor 52	03	118	32-bit Float
Read Sensor 61	03	120	32-bit Float
Read Sensor 62	03	122	32-bit Float
Read Sensor 71	03	124	32-bit Float
Read Sensor 72	03	126	32-bit Float
Read Sensor 81	03	128	32-bit Float
Read Sensor 82	03	130	32-bit Float

Read Analog Input 1	03	300	32-bit Float
Read Analog Input 2	03	302	32-bit Float
Read Analog Input 3	03	304	32-bit Float
Read Analog Input 4	03	306	32-bit Float

Relay 1 Description	03	1000	64 bytes UTF-8
Relay 2 Description	03	1032	64 bytes UTF-8
Relay 3 Description	03	1064	64 bytes UTF-8
Relay 4 Description	03	1096	64 bytes UTF-8

Digital Input 1 Description	03	3200	64 bytes UTF-8
Digital Input 2 Description	03	3232	64 bytes UTF-8
Digital Input 3 Description	03	3264	64 bytes UTF-8
Digital Input 4 Description	03	3296	64 bytes UTF-8

Sensor 1 Description	03	5400	64 bytes UTF-8
Sensor 2 Description	03	5432	64 bytes UTF-8
Sensor 3 Description	03	5464	64 bytes UTF-8
Sensor 4 Description	03	5496	64 bytes UTF-8
Sensor 5 Description	03	5528	64 bytes UTF-8
Sensor 6 Description	03	5560	64 bytes UTF-8
Sensor 7 Description	03	5592	64 bytes UTF-8
Sensor 8 Description	03	5624	64 bytes UTF-8

Analog Input 1 Description	03	7600	64 bytes UTF-8
Analog Input 2 Description	03	7632	64 bytes UTF-8
Analog Input 2 Description	03	7664	64 bytes UTF-8
Analog Input 2 Description	03	7696	64 bytes UTF-8

Sensor 11 Dimension	03	9800	64 bytes UTF-8
Sensor 12 Dimension	03	9832	64 bytes UTF-8
Sensor 21 Dimension	03	9864	64 bytes UTF-8
Sensor 22 Dimension	03	9896	64 bytes UTF-8
Sensor 31 Dimension	03	9928	64 bytes UTF-8
Sensor 32 Dimension	03	9960	64 bytes UTF-8
Sensor 41 Dimension	03	9992	64 bytes UTF-8
Sensor 42 Dimension	03	10024	64 bytes UTF-8
Sensor 51 Dimension	03	10056	64 bytes UTF-8

Sensor 52 Dimension	03	10088	64 bytes UTF-8
Sensor 61 Dimension	03	10120	64 bytes UTF-8
Sensor 62 Dimension	03	10152	64 bytes UTF-8
Sensor 71 Dimension	03	10184	64 bytes UTF-8
Sensor 72 Dimension	03	10216	64 bytes UTF-8
Sensor 81 Dimension	03	10248	64 bytes UTF-8
Sensor 82 Dimension	03	10280	64 bytes UTF-8

Analog Input 1 Dimension	03	12000	64 bytes UTF-8
Analog Input 2 Dimension	03	12032	64 bytes UTF-8
Analog Input 3 Dimension	03	12064	64 bytes UTF-8
Analog Input 4 Dimension	03	12096	64 bytes UTF-8

9. Firmware update

TCW241 can be updated via WEB interface.

To update the device follow the steps below:

- Go to **www.teracom.cc** and download the latest firmware;
- From **Administration->FW update** select downloaded .cod file and press “upload” button;
- After the firmware update is completed, Login page will appears.

Attention! Don't turn off the power supply during the update. Turning off the power supply will damage the device.

10. Factory default settings

TCW241 can be restored to its original factory default settings in 3 different ways.

9.1. Factory default from WEB interface

If the button “Factory default” from Administration->Backup/Restore is pressed, all parameters return to factory default except Network settings.

9.2. Factory default with reset button

If the reset button is pressed for more than 5 seconds, while the device is working, all Network settings go factory default.

9.3. General factory default with reset button

For factory default reset of all parameters following steps should be executed:

- Press and hold the RESET button, then turn on the power supply;
- Yellow LED shines and red LED blinks about 5 time on a second;
- After about 5 seconds red LED will turn off, button can be released;
- Yellow LED flashes on 1 second and red LED shines – device is in working mode, with factory default settings.



The factory default settings are:

User Name	admin
Password	admin
IP Address	192.168.1.2
Subnet Mask	255.255.255.0
Default Gateway	192.168.1.1
SNMPConfiguration	disabled
readCommunity	public
writeCommunity	private
Analog inputs unit	voltage
Analog inputs multiplier	1.000
Analog inputs ofset	0.000

11. Environment information

This equipment is intended for use in a Pollution Degree 2 environment, at altitudes up to 2000 meters.

When the controller is a part of a system, the other elements of the system shall comply with the EMC requirements and shall be intended for use in the same ambient conditions.

12. Safety

This device must not be used for medical, life saving purposes or for any purpose where its failure could cause serious injury or the loss of life.

To reduce the risk of fire, only flexible stranded wire, with cross section 0.5mm² or larger for wiring of digital and analog inputs and relay output of the device should be used.

To avoid electric shock and fire hazard, do not expose this product to liquids, rain, or moisture. Objects filled with liquids, such as vases, should not be placed on this device.

There is a risk of overheating (damage) of controller, if recommended free spaces to adjacent devices are not ensured. Joint part with external component shall have space for attachment/removal of the cable after installation.

Teracom does not guarantee successful operation of the product if the product was used under conditions deviating from the product specifications.

To ensure that the device works correctly follow the steps below:

- ensure that the device is installed correctly, refer this user manual;
- log in to the devices via browser program;
- make proper set up;

- set up the digital inputs to work in “dry contact” mode;
- short the “Din1” and “GND”;
- install sensor TSH1XX or TST1XX on 1-Wire bus;
- go to “Monitoring page” of WEB interface – proper parameters value should be displayed in the same time flashing “STS” led should indicate the proper operation.

If the equipment is used in a manner not specified by the manufacturer, the protection provided by the equipment may be impaired.

In no event will Teracom Ltd. be responsible or liable for indirect or consequential damages resulting from the use or application of this equipment.

13. Maintenance

Upon completion of any service or repairs to the device or once per year, safety check must be performed to determine that this product is in proper operating condition.

Clean the device only with dry cloth. Do not use a liquid cleaner or an aerosol cleaner. Do not use a magnetic/static cleaning device (dust remover) or any kind of abrasive materials to clean the device.

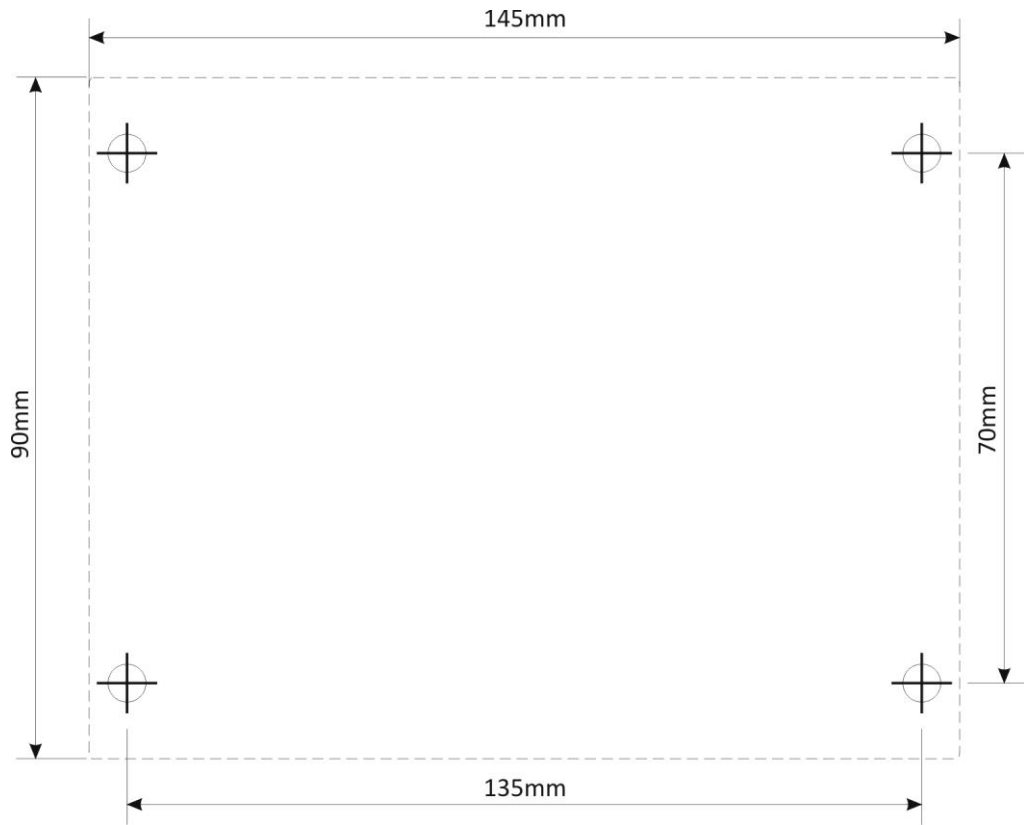

Fig.1

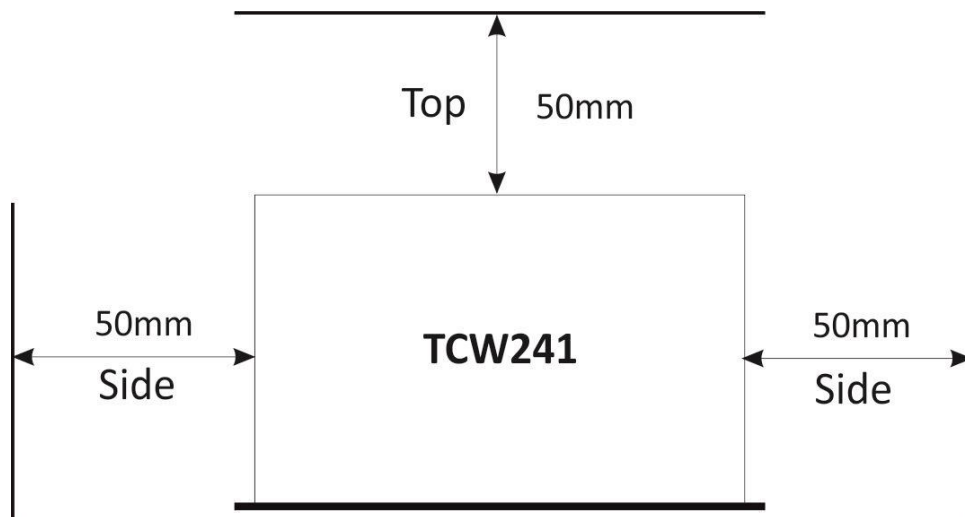

Fig.2